

Handbook on  
**Design and Construction of Housing for  
Flood-Prone Rural Areas of Bangladesh**





The Asian Disaster Preparedness Center (ADPC) is a regional resource center dedicated to disaster reduction for safer communities and sustainable development through disaster reduction in Asia and the Pacific. Established in 1986 in Bangkok, Thailand, ADPC is recognized as an important focal point for promoting disaster awareness and developing capacities to foster institutionalized disaster management and mitigation policies.



The Bangladesh Disaster Preparedness Center (BDPC), established in 1996 in Dhaka, works towards the goal of integration of disaster management into development planning at the national level through research, training, documentation, awareness building, etc.



CARE Bangladesh is a part of CARE International, one of the world's largest private international humanitarian organizations, enabling families in poor communities to improve their lives and overcome poverty. Working in Bangladesh since 1949, CARE partners with communities, community based organizations, the Government and national NGOs to identify and confront root causes of the poverty.



The Comprehensive Disaster Management Programme under the Bangladesh Ministry of Food and Disaster Management is an initiative to achieve a paradigm shift in disaster management from conventional response and relief to a more comprehensive risk reduction culture. It works in collaboration with the United Nations Development Programme (UNDP) and the U.K. Department for International Development (DFID), which are major sponsors.



BRAC University, an institution of BRAC, which is one of the largest non-governmental organizations in the world, provides tertiary level education to support the national development process. It runs several courses and programmes related to development and disaster management.



United States Agency for International Development (USAID) is an agency that provides economic, development and humanitarian assistance around the world in support of the foreign policy goals of the United States. USAID is currently supporting the implementation of ADPC's Asian Urban Disaster Mitigation Program.

The Asian Urban Disaster Mitigation Program (AUDMP) of ADPC Bangkok is a ten-year (1995-2005) program designed to reduce the natural disaster vulnerability of urban populations, infrastructure, critical facilities and shelters in Asian cities. AUDMP aims to demonstrate the importance of and strategic approaches to urban disaster mitigation as part of the urban development planning process. AUDMP projects are being implemented in 10 countries - Bangladesh, Cambodia, India, Indonesia, Lao PDR, Nepal, Philippines, Sri Lanka, Thailand and Vietnam.

Handbook on  
**Design and Construction of Housing  
for Flood-prone Rural Areas of Bangladesh**

January 2005

Published by



**Asian Disaster Preparedness Center**

in partnership with

**Bangladesh Disaster Preparedness Center**

**CARE-Bangladesh**

**Bangladesh Ministry of Food and Disaster Management/**

**Comprehensive Disaster Management Programme**

**BRAC University**

with support from

**United States Agency for International Development**



#### Advisory Committee

Dr. Suvit Yodmani, *ADPC, Bangkok*  
Mr. Earl Kessler, *ADPC, Bangkok*  
Mr. Aloysius J. Rego, *ADPC, Bangkok*  
Prof. Jamilur Reza Choudhury, *BRAC University, Dhaka*

#### Review Committee

Mr. Golam Kabir, *USAID Bangladesh*  
Mr. Muhammad Saidur Rahman, *BDPC Bangladesh*  
Mr. Monzu Morshed, *CARE Bangladesh*  
Mr. NMSI Arambepola, *ADPC Bangkok*  
Mr. Rajesh Sharma, *ADPC Bangkok*

Author: **Dr. K. Iftekhar Ahmed**

*Drawings by the author with support from Mr. Kh.Hasibul Kabir and Mr. Ekushey Ahmed for cover drawings. Photographs by the author or as credited.*

ISBN: 984-32-2163-X

Printed by Nymphaea, 67/D, Panthapath, Dhaka-1209, Bangladesh

This handbook is published under the Asian Urban Disaster Mitigation Program (AUDMP) of ADPC Bangkok for sharing knowledge and experiences from the participating countries in the project. It is made available by the Asian Disaster Preparedness Center, Bangkok, Thailand, with minimal editing. The opinions expressed herein are those of the author and do not necessarily reflect the views of Asian Disaster Preparedness Center, Bangladesh Disaster Preparedness Center, Care-Bangladesh, Bangladesh Ministry of Food and Disaster Management/ Comprehensive Disaster Management Programme, BRAC University or the U.S. Agency for International Development. Publication of this handbook was made possible through support provided by the Office of Foreign Disaster Assistance, United States Agency for International Development, under the terms of Cooperative Agreement No. DFD-A-00-03-00077-00.

The contents of this handbook may be freely quoted with credit given to the implementing institutions, Asian Disaster Preparedness Center and to the Office of Foreign Disaster Assistance of the U.S. Agency for International Development.

Copyright © ADPC 2005

# PREFACE

It is with great pleasure that ADPC presents the handbook on “Design and Construction of Housing for Flood-Prone Rural Areas of Bangladesh”.

It is a well-known fact that Bangladesh is a highly flood-prone country. As the result of annual floods, significant number of houses in the countryside as well as in urban areas is being destroyed annually. In recent floods during year 2004 we have seen a total or partial destruction to significant number of rural houses making about 1 million people homeless. To a large extent, the patterns and causes of destruction seem to result from poor technical knowledge and wrong perceptions. There is no adequate support for housing projects for low-income, flood-vulnerable communities through development projects undertaken by NGOs and the government, and dwelling houses in rural areas and urban slums are mostly owner-built without proper technical guidance.

ADPC under its Asian Urban Disaster Mitigation Program (AUDMP) has supported CARE Bangladesh in implementation of Bangladesh Urban Disaster Mitigation project (BUDMP) in six municipalities. One of the AUDMP findings of post-disaster losses of the housing stock in Bangladesh after 2004 floods is that most of these designs are prepared by people who are not trained as building professionals, so when implemented, many problems emerge. The usual tendency is to apply the same model irrespective of the context. In most cases, the cost is significantly prohibitive in terms of microcredit recovery from poor people and this high cost prevents providing subsidized housing to a large number of people who need them. There is thus a need for developing housing which is appropriate for flood-prone areas, where the suggested solutions can be made 'cost-effective' through rationalization of economy without compromising quality.

While there have been successful initiatives towards improving the performance of new construction by incorporation of appropriate designs, cost-effective flood-resistant techniques and building materials in the building construction process in many countries, little has been done in Bangladesh to that effect. It is generally anticipated that house owners, local masons and small contractors will continue to play significant role in the building construction process for low-income groups, and any improvement in their skills in flood-resistant construction can significantly help to improve the quality standards of non-engineered buildings and hence considerable reduction in loss of human lives and properties during floods.

The author Dr. K. Iftekhar Ahmed has presented number of improvements in the handbook, which can be easily adopted in the building construction and guidelines suggested by him through longstanding experience in low cost house design in Bangladesh are easy to follow. Therefore particular thanks are extended to him and his graphic designers Mr. Kh. Hasibul Kabir and Ekushey Ahmed for their contributions in developing this handbook. Thanks are due to my colleagues of the advisory committee Mr. Earl Kessler (ADPC), Mr. Aloysius J. Rego (ADPC) and Prof. Jamilur Reza Choudhury (BRAC University). Thanks also to the technical review committee members Mr. Golam Kabir (USAID, Bangladesh), Mr. Muhammad Saidur Rahman, Bangladesh Disaster Preparedness Center (BDPC), Mr. Monzu Morshed of CARE, Bangladesh and ADPC colleagues Mr. N.M.S.I. Arambepola and Mr. Rajesh Sharma.

ADPC expects to disseminate the handbook among government and private sector institutions, international funding organizations, national and international non-governmental organizations (NGOs), private voluntary development organizations (PVDOs), community based organizations (CBOs), micro-financing institutions and other groups willing to support new housing projects, post-disaster reconstruction and rehabilitation projects or projects on housing strengthening/retrofitting.

We firmly believe that this joint effort of ADPC and its partners in CARE-Bangladesh and Bangladesh Disaster Preparedness Center (BDPC) in bringing out this Handbook on “Design and Construction of Housing for Flood-Prone Rural Areas of Bangladesh” will contribute to safer buildings in flood prone areas of Bangladesh.

Dr. Suvit Yodmani  
Executive Director  
ADPC, Bangkok

January 2005

# Table of Contents

## Chapter 1

### INTRODUCTION

- 1.1 RATIONALE FOR PRODUCING THIS HANDBOOK
- 1.2 KEY FACILITATORS
- 1.3 TARGET GROUPS
- 1.4 HOUSING TYPES
- 1.5 REASONS FOR DAMAGE TO HOUSING IN FLOODS
- 1.6 EFFECTS OF FLOOD ON DIFFERENT PARTS OF BUILDINGS
- 1.7 INSTRUCTIONS ON USING THIS HANDBOOK

## Chapter 2

### APPROPRIATE CONSTRUCTION OPTIONS

- 2.1 PLINTH
- 2.2 POSTS
- 2.3 WALLS
- 2.4 ROOFING

## Chapter 3

### BAMBOO CONSTRUCTION

- 3.1 CATEGORIES AND USES IN HOUSE CONSTRUCTION
- 3.2 PROPERTIES
- 3.3 TRADITIONAL BAMBOO TREATMENT
- 3.4 CHEMICAL PRESERVATIVE METHODS
- 3.5 DESIGN ASPECTS
- 3.6 ECONOMIC FEASIBILITY OF CHEMICAL PRESERVATIVE TREATMENT

## Chapter 4

### EARTH CONSTRUCTION

- 4.1 LIMITATIONS
- 4.2 REMEDIAL MEASURES
- 4.3 STABILIZED EARTH CONSTRUCTION METHODS
- 4.4 DESIGN ASPECTS
- 4.5 ECONOMIC FEASIBILITY OF CEMENT-STABILIZATION

## Chapter 5

### INNOVATIVE AND ALTERNATIVE METHODS

- 5.1 CONCRETE
- 5.2 FERROCEMENT
- 5.3 METAL SECTIONS
- 5.4 TIMBER
- 5.5 STILTS

## Chapter 6

### WIDER LINKAGES

- 6.1 DESIGN AND LAYOUT OF HOMESTEADS
- 6.2 LAND SUITABILITY
- 6.3 HOMESTEAD RAISING
- 6.4 LANDSCAPING
- 6.5 CULTIVATION OF NATURAL BUILDING RESOURCES
- 6.6 BASIC INFRASTRUCTURE
- 6.7 FINANCING
- 6.8 LIVELIHOOD OPTIONS

# Chapter 1 INTRODUCTION

## 1.1 RATIONALE FOR PRODUCING THIS HANDBOOK

- A large proportion of the countryside as well as the majority of urban areas in Bangladesh is flood-prone. During heavy flood, more than 60% of the land is inundated.
- Recent floods in 2004 has destroyed many houses and about 1 million people became homeless. To a large extent, the patterns and causes of destruction seem to result from poor technical knowledge and wrong perceptions.
- Technocrats do not adequately support housing projects for low-income, flood-vulnerable communities undertaken by NGOs and the government, and houses are mostly owner-built without proper technical guidance.
- One of the AUDMP findings of post disaster losses of the housing stock in Bangladesh after 2004 floods is that most of these designs are prepared by people who are not trained as building professionals, so when implemented, many problems emerge.
- The usual tendency is to apply the same model irrespective of context - for example, the same house design is built on highland and low-lying flood-prone areas.
- In most cases, the cost is significantly prohibitive in terms of microcredit recovery from poor people and this high cost prevents providing subsidized housing to a large number of people who need them.
- There is thus a need for developing housing which is appropriate for flood-prone areas, where the suggested solutions are ‘cost-effective’ - that is, rationalization of economy without compromising quality.
- Those who work in the low-income housing sector in Bangladesh in general are still to adopt such techniques.



Fig. 1.1 Extent of Flood 2004  
(Source: www.reliefweb.map)





## 1.2 KEY FACILITATORS

Institutions, organizations and groups willing to support new housing projects, post-disaster reconstruction and rehabilitation projects or projects on housing strengthening/ retrofitting. This includes:

- ❑ Government of Bangladesh
- ❑ Local government institutions
- ❑ International funding organizations
- ❑ National and international non-governmental organizations (NGOs) and private voluntary development organizations (PVDOs)
- ❑ Community based organizations (CBOs)
- ❑ Micro-financing institutions



*Photo: Shams Mansoor Ghani*

## 1.3 TARGET GROUPS

- ❑ Wide cross-section of communities living in the predominantly flood-prone rural areas of Bangladesh.
- ❑ Communities living in flood-prone municipalities and areas under local government administration.



## 1.4 HOUSING TYPES



Fig. 1.2 Kutcha House

### 1.4.1 Kutcha House

- ❑ **Foundation:** Earthen plinth with bamboo (sometimes timber) posts.
- ❑ **Walls:** Organic materials - jutestick, catkin grass, straw, bamboo mats, etc. Split bamboo framing. Earthen walls in some areas.
- ❑ **Roof:** Thatch - rice or wheat or maize straw, catkin grass, etc with split bamboo or sometimes reed stalk framing.



Fig. 1.3 Semi-Pucca House

### 1.4.2 Semi-Pucca House

- ❑ **Foundation:** Earthen plinth; Brick perimeter wall with earth infill; Brick and concrete.
- ❑ **Walls:** Bamboo mats; CI sheet; Timber (sometimes split bamboo) framing. Earthen walls in some areas. Sometimes part or full brick.
- ❑ **Roof:** CI sheet with timber framing (sometimes split bamboo).



Fig. 1.4 Pucca House

### 1.4.3 Pucca House

- ❑ **Foundation:** Brick and concrete.
- ❑ **Walls:** Brick.
- ❑ **Roof:** Reinforced concrete (RC).

## 1.5 REASONS FOR DAMAGE TO HOUSING IN FLOODS

- The impact of floods to housing is due to several reasons: a) Flood depth, b) Flood duration, 3) Uplift due to soil saturation and 4) Horizontal force created by flood waves or currents.
- Direct flood hazard is associated with other types of secondary hazards such as high winds or storms, lightning, slope instability, ground settlement, etc.
- Floodwater can submerge buildings and cause various degrees of damage from staining of walls to structural collapse depending on flood depth and/ or duration and type of building.

## 1.6 EFFECTS OF FLOOD ON DIFFERENT PARTS OF BUILDINGS

### 1.6.1 Foundation

- **Type 1 – Earthen:** In kutcha houses with usually bamboo and sometimes timber posts embedded directly into the earthen plinth. Extremely vulnerable and get damaged even in low intensity flood, thus requiring frequent maintenance. In moderate to high intensity flood, especially if accompanied by currents, earthen plinths tend to get completely washed off and have to be rebuilt. Bamboo or timber posts in saturated soil, especially during long duration or recurrent flood, get rotten at the base, thus weakening the entire structure of the buildings to damage by strong wind, differential settlement, sagging of roofing elements and doors, windows and wall elements developing cracks and losing alignment. Frequent replacement of bamboo posts of kutcha houses is done regularly in flood-prone areas. The typical earthen plinth in many semi-pucca houses also behaves similarly.
- **Type 2 – Brick perimeter:** In semi-pucca houses, locally known as “dowa-posta”, is better at resisting erosion at the sides of a building, but the infill earth floor can experience settlement due to saturation and in prolonged flood can become muddy, unusable and the mud can escape from below. At the same time, scouring of soil cover of the typically shallow foundation of the perimeter brick wall can result in its instability and settlement.
- **Type 3 – Brick and concrete:** Usually in pucca and sometimes also in semi-pucca houses. Relatively durable, but in high intensity flood accompanied by currents, shallow foundations can become unstable due to scouring of soil-cover. Prolonged duration flood can lead to foundation settlement, thereby causing cracks and failures in different parts of the building.

## 1.6.2 Walls

- **Type 1 – Organic/ Bamboo mat:** Typically in kutcha houses; semi-pucca houses also often have bamboo mat walls. Organic materials (e.g. jutestick, catkin grass) have a lifespan of 2-3 years and bamboo mat 4-5 years. Decay can get accelerated in flood. In flood of high depth and moderate duration, the damage begins in the lower part of walls and hence weakens the walls and eventually results in complete damage. Flood with strong currents can detach wall panels and wash them away, leading to partial or complete loss, especially if the connections to posts are weak.
- **Type 2 – CI sheet:** Used in semi-pucca houses with timber framing. Contact with water leads to corrosion and gets aggravated in flood. The lower part of walls are particularly vulnerable if plinth is not sufficiently above flood level or if flood depth is high. Prolonged duration flood can cause damage to lower end of CI sheet wall panels and timber frame. Flood with strong current can detach and wash away wall panels, especially if not adequately secured to frame.
- **Type 3 – Earth:** Used in kutcha and semi-pucca houses. Various types according to region, but not prevalent in all areas. In monolithic construction, flood water can cause serious damage: once the base gets affected, the entire structure is liable to collapse, often rapidly. Earthen walls with an internal framework, as in some parts of Sylhet district, are less vulnerable; even if the earth cover is washed away, the building remains standing and can be repaired (see section 2.3.4.1).
- **Type 4 – Brick:** Usually in pucca and sometimes also in semi-pucca houses. Relatively durable, but can experience staining, peeling of plaster and weakening of mortar joints at lower ends if immersed in flood of high depth and duration. Cracks may develop if settlement of foundation occurs.

*NOTE: Effect of flood on doors and windows varies according to the type of material. Most durable are mild steel (MS) frame and shutters, or glass shutters, although they may experience corrosion if not adequately painted with corrosion-resistant paint. Bamboo or timber frames are vulnerable, especially if timber is not of good quality, not seasoned and treated properly.*

### 1.6.3 Roof

- **Type 1 – Thatch:** Typically in kutcha houses, made from catkin grass, rice, wheat or maize straw with usually bamboo and sometimes reed stalk framing. Normally has to be renewed every 2-3 years. Results in decay in houses of low height and during flood of very high depth and duration, if thatch comes into contact with flood water. In such conditions, if also accompanied by strong current, thatching materials can get detached and washed away. Secondary hazard often connected to flood is heavy rainfall, which can cause damage. Strong wind can also blow away thatching materials and damage frame.
  
- **Type 2 – CI sheet:** Used in semi-pucca houses usually with timber framing, sometimes with bamboo framing and in some cases without any framing. Can lead to corrosion in contact with water and vulnerable to secondary hazard of heavy rainfall accompanying flood. Particularly vulnerable to strong wind – can crumple and get blown off, especially if connections to frame are inadequate. During flood can offer a limited degree of rooftop refuge.
  
- **Type 3 – Reinforced concrete (RC):** Relatively durable, used in pucca houses. Can withstand impact of heavy rainfall and wind, but can get weakened and may even collapse if foundation settles or walls are damaged. Offers a high degree of rooftop refuge during flood.

## 1.7 INSTRUCTIONS ON USING THIS HANDBOOK

- Chapter 1 provides an introduction to the effects of flood on rural housing in Bangladesh - a recurrent event - the reason for writing this handbook. This allows for creating an understanding of the broader framework within which this handbook is to be used for addressing this problem by organizations, communities and individuals that are concerned with mitigating damage to housing by flood.
- Chapters 2, 3, 4 and 5 deal with a variety of construction and design aspects developed, proposed or used elsewhere that have potential for mitigating flood damage to rural housing. Although for thematic categorization these chapters each deal with a particular form of construction, it is possible to combine the different **OPTIONS** discussed under each chapter to arrive at designs that are appropriate for specific contexts.
- The judgment, experience and choice of the implementer or user would play an important role in deciding which combination of **PLINTH**, **POST**, **WALLS** and **ROOFING** would be suitable, thus allowing flexibility in house design and user participation.
- This handbook can also serve as a training manual, where the trainer should facilitate discussion among stakeholders to decide upon appropriate house designs based on assessment of the different construction options for the main parts of a house provided here.
- The table in Fig. 1.5 below has been prepared to assist in this process. The serial numbering of the options according to their positions within chapters have been shown in the table to allow navigating within the handbook.
- Chapter 6 links the specific design and construction options to wider aspects of housing development systems. These linkages point the user of this handbook to the range of issues that need to be addressed to develop flood-safe and habitable settlements in rural Bangladesh, where these issues would need to be understood in much greater detail than possible within the scope of this handbook.

	<b>PLINTH</b>		<b>POST</b>		<b>WALLS</b>		<b>ROOFING</b>
2.1.1	Cement Stabilization	2.2.1	Coating Lower End	2.3.1.1	Detachable Lower Panel	2.4.1	Chemical Treatment of Thatch
2.1.2	Brick Perimeter Wall	2.2.2	Concrete Stump ( <i>Katla</i> )	2.3.1.2	Painting with Bitumen	2.4.2	Wind-Resistant Roofing
2.1.3	Brick and Concrete	2.2.3	R.C. Post	2.3.1.3	Protective Lower Panel ( <i>Gorani</i> )	2.4.3	Rainwater Gutter
		3.4.2.2	Internodal Injection Method	2.3.1.3	Rain Protector ( <i>Bhelki</i> )	5.2	Ferrocement
		3.4.2.3	Hot and Cold Method	2.3.2	Chemical Treatment of Bamboo Mat Walls	5.3.2	Metal Roof Structure
				3.4.2.1	Dip Diffusion Method		
		5.1.1	Hollow Concrete Stump	2.3.3	Cross-Bracing	5.4	Timber
		5.1.2	Hollow Cylindrical R.C. Post	4.2.1.1	Basic Guidelines for Wattle and Daub Construction		
		5.3.1	Metal Post	4.2.1.2	Double Layer Framework with Earth Infill		
		5.4	Timber	2.3.4.2	Cement Stabilization		
		5.5	Stilts	4.3.1	Compressed Earth Blocks		
				4.3.2	Rammed Earth		
				5.2	Ferrocement		
				5.4	Timber		
	<b>FOR BOTH</b>		<b>BAMBOO POSTS</b>		<b>AND WALLS</b>		
		3.3.1	Soaking Bamboo in Water	3.4.1.1	Chemical Preservative - CCA		
		3.3.2	Clump Curing of Bamboo	3.4.1.2	Chemical Preservative - CCB		
		3.3.3	Bamboo Seasoning	3.4.1.3	Chemical Preservative - Oils		

Fig. 1.5 List of Construction Options to Develop Appropriate Design

## Chapter 2 APPROPRIATE CONSTRUCTION OPTIONS

### 2.1 PLINTH

#### 2.1.1 Cement Stabilization

- ❑ Stabilization of the typical earthen plinth can be carried out with a mixture of earth and cement.
- ❑ The proportion of cement to be added depends on the nature of the soil (see section 4.2.2), which can easily be tested on site.
- ❑ For soil with more than 40% sandy-silty particles, 5% cement additive is adequate. For soil with less sandy content, sand has to be added to raise the content above 40% and may require a somewhat higher proportion of cement additive.
- ❑ Test blocks should be made on site to determine the suitability and proportions of the mixture, keeping in mind the above point.
- ❑ Soil should be crushed and sieved into a fine form and cement in the right proportion to be added in dry state.
- ❑ Moistened with water and should be immediately used. Wet mixture left unused for too long becomes unusable as it begins to set and harden.
- ❑ Stabilization works best together with compaction. Can be cast and compacted by hand and finished with a trowel.
- ❑ For further compaction, a simple hand rammer or wooden battens can be used.
- ❑ At least 3 weeks curing by water should be done. Can be covered by jute sacks to keep moist and water poured at regular intervals to avoid drying.
- ❑ Capping the plinth with cement stabilized earth is cheaper, easier to construct and maintain.
- ❑ Complete stabilized earth plinth is more expensive and harder to construct, but the results are more durable.





Fig. 2.1 Cement-stabilized earthen plinth

1. Cement-stabilized plinth construction process

2. Details of cement-stabilized plinth.

3. A stabilized plinth (right) resists water much better than an unstabilized one (left).

Note how the left plinth is trying to be protected with polythene sheets

## 2.1.2 Brick Perimeter Wall

- Locally known as “dowa-posta”, a brick perimeter wall around the typical earthen plinth resists erosion from the sides.
- If soil is too weak or loose, the foundation of the perimeter wall should penetrate to sufficient depth, preferably with a spread footing.
- Since very little load is imposed on the wall, the footing can be constructed with brick without the need for a concrete footing.
- Minimum 1:4 cement-sand mix should be used.
- Soil cover on the foundation should be thoroughly compacted and should preferably have plant or grassy cover to prevent scouring during flood.
- Infill should be of cement-stabilized soil to prevent muddiness, settlement due to saturation and loss of soil from below.



*Fig. 2.2 “Dowa-posta” plinth construction*

## 2.1.3 Brick and Concrete

- This is a relatively expensive option, but more durable and flood-resistant.
- Should properly compact sub-base soil to avoid settlement. If necessary, can provide a layer of sand filling.
- If soil is too weak or loose, a layer of brick soling should be provided.
- Soil cover on the foundation should be thoroughly compacted and should preferably have plant or grassy cover to prevent scouring during flood.
- 4 inch cement concrete base slab @ 1:5:10 = cement : sand : aggregate (brick chips, 1½ inch nominal size).
- 1 inch cement concrete topping @ 1:2:4 = cement : sand : aggregate (fine brick chips).

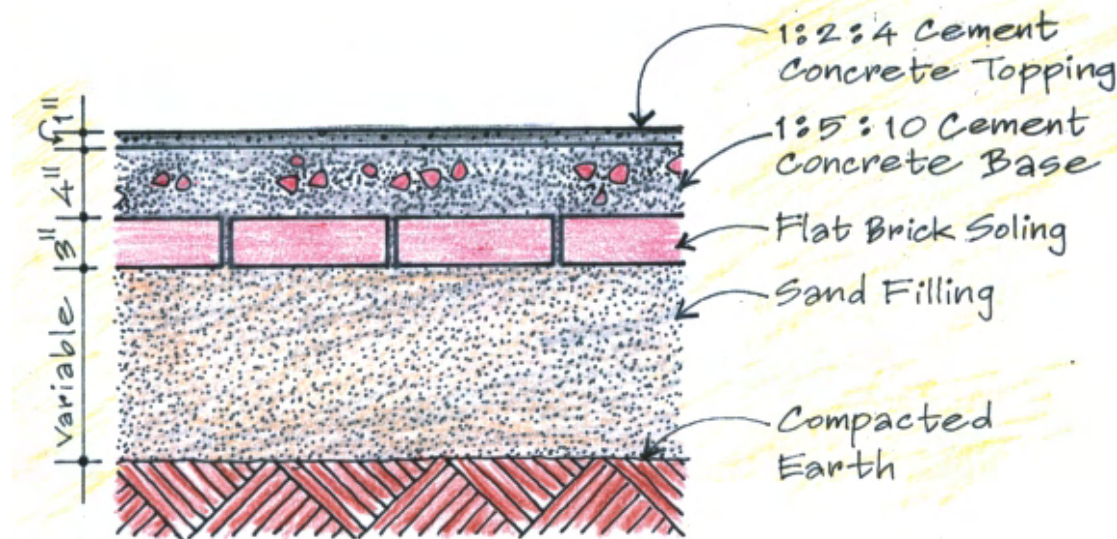

Fig. 2.3 Cement concrete flooring detail and house with cement concrete plinth

## 2.2 POSTS

### 2.2.1 Coating Lower End

- ❑ Cheapest method for protecting from dampness lower end of bamboo/ timber posts typically embedded into the ground.
- ❑ Local method known by most villagers, but not widely practiced, and thus requires promotion.
- ❑ Molten bitumen, Mobil or sump oil, or a combination of these can be used.
- ❑ Should paint the lower end with brush or cloth and continue coating above plinth level according to last flood level.
- ❑ Provides mainly damp-proofing, does not prevent much insect or fungal attack.
- ❑ Extends life of bamboo post by a couple of years or so.
- ❑ For chemical preservative treatment of bamboo posts, see section 3.4.



*Fig. 2.4 Painting lower end of bamboo post with bitumen*

## 2.2.2 Concrete Stump (*Kaatla*)

- ❑ Local method for protecting the base of bamboo/ timber posts by supporting on concrete stumps embedded into the plinth or ground and connecting them by MS (mild steel) clamps. Locally known as *kaatla* or *shiri*.
- ❑ Possible to reduce cost by 10% by making the *kaatla* partially hollow. Space can be filled with sand/ earth before placing in the ground and strength is not compromised.
- ❑ Greatest advantage is reduction of recurrent expenditure on replacing bamboo posts; a bamboo post protected from the ground by *kaatla* lasts five years or longer, representing more than double lifespan.
- ❑ For a bamboo post supported on *kaatla*, it is better to paint lower end with bitumen for additional damp-proofing. Termite shield made of polythene or metal can be used in the space between bottom of post and above *kaatla* top.
- ❑ Polythene sheets to be spread on the ground and a 4-sided wooden shuttering placed according to *kaatla* dimensions, given below.
- ❑ For each *katla*, at one end a 10-12 inch long  $\frac{1}{4}$  inch thick MS flat bar to be placed in position so that after casting it is embedded by 4-6 inch into the *kaatla*.
- ❑ The bar should have two  $\frac{3}{8}$  inch holes towards the upper end to insert screws for attaching the post, thus serving as a clamp.
- ❑ Casting is to be done with a 1:4:4 (cement : sand : aggregate –  $\frac{1}{2}$  inch brick chips) mix to make 5 inch x 4 inch x 2 feet *kaatla*.
- ❑ At least 3 weeks curing by water is necessary.
- ❑ To prevent rust, the MS clamps can be painted with molten bitumen.
- ❑ For efficient use of wooden shutters, better cost-effectiveness and production, it is advantageous to produce a number of *kaatlas* together.

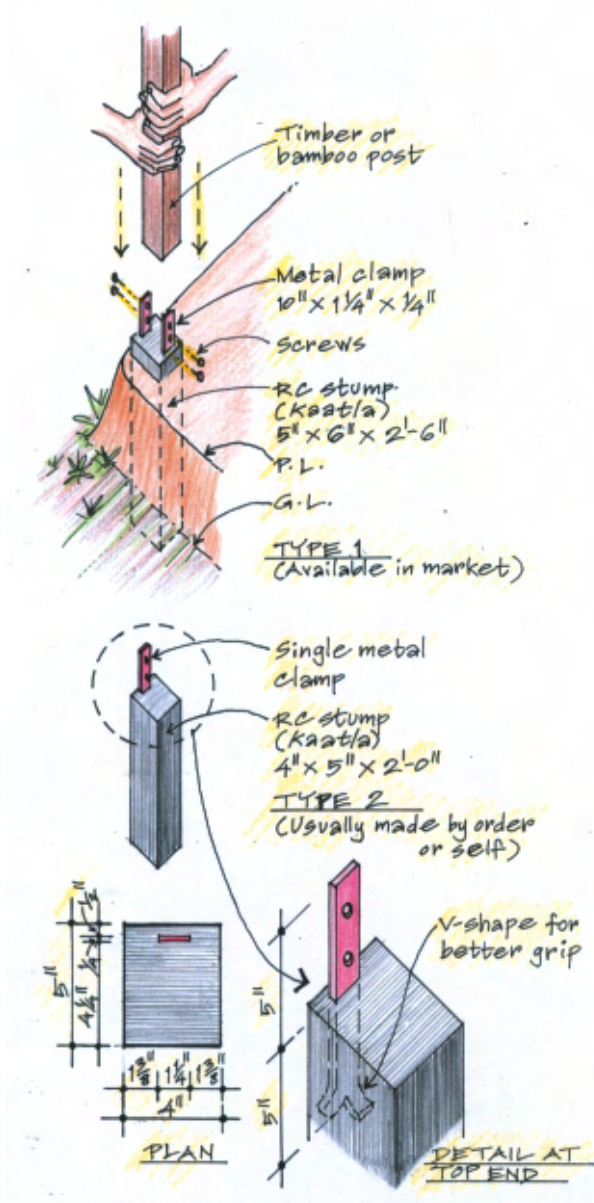

Fig. 2.5 Concrete stump (kaatla) for protecting lower end of bamboo post

### 2.2.3 RC (Reinforced Concrete) Post

- ❑ Relatively expensive option, but resistant to deterioration by water.
- ❑ Better to produce on site to avoid handling and transport costs.
- ❑ If affordable, all posts of the house should be of RC. Otherwise, if some posts are bamboo or timber, they may rot at base and the structure can become weakened and hazardous and roof structure may sag and even collapse.
- ❑ Should use four steel  $\frac{3}{8}$  inch diameter re-bars, one at each corner, tied together with  $\frac{1}{4}$  inch diameter stirrups @ 8-10 inch nominal spacing.
- ❑ Length should be determined according to depth of penetration required into plinth and ground according to local soil conditions and plinth height. Minimum 9 feet. More depth of penetration required for weak, loose or wet soil.
- ❑ Post section = 4 inch x 4 inch.
- ❑ Better to have a small spread footing for stability and to avoid leaning over during flood.
- ❑ For attaching to roof structure, can have a  $\frac{5}{8}$  inch re-bar projecting 6-8 inch from top and embedded 6-8 inch into the post. Re-bar can be bent around purlin for better grip. To prevent rust, the re-bar should be painted with molten bitumen.
- ❑ Can also use MS flat bar clamp (similar as in *kaatla*; see section 2.2.2) for screwing on to roof structure.
- ❑ Casting is to be done with mix of 1:4:6 (cement : sand : aggregate –  $\frac{1}{2}$  inch brick chips) in horizontal position on the ground, using re-useable wooden shuttering.
- ❑ At least 3 weeks curing by water is necessary.
- ❑ Caution should be taken to avoid corner chipping during handling and installation.

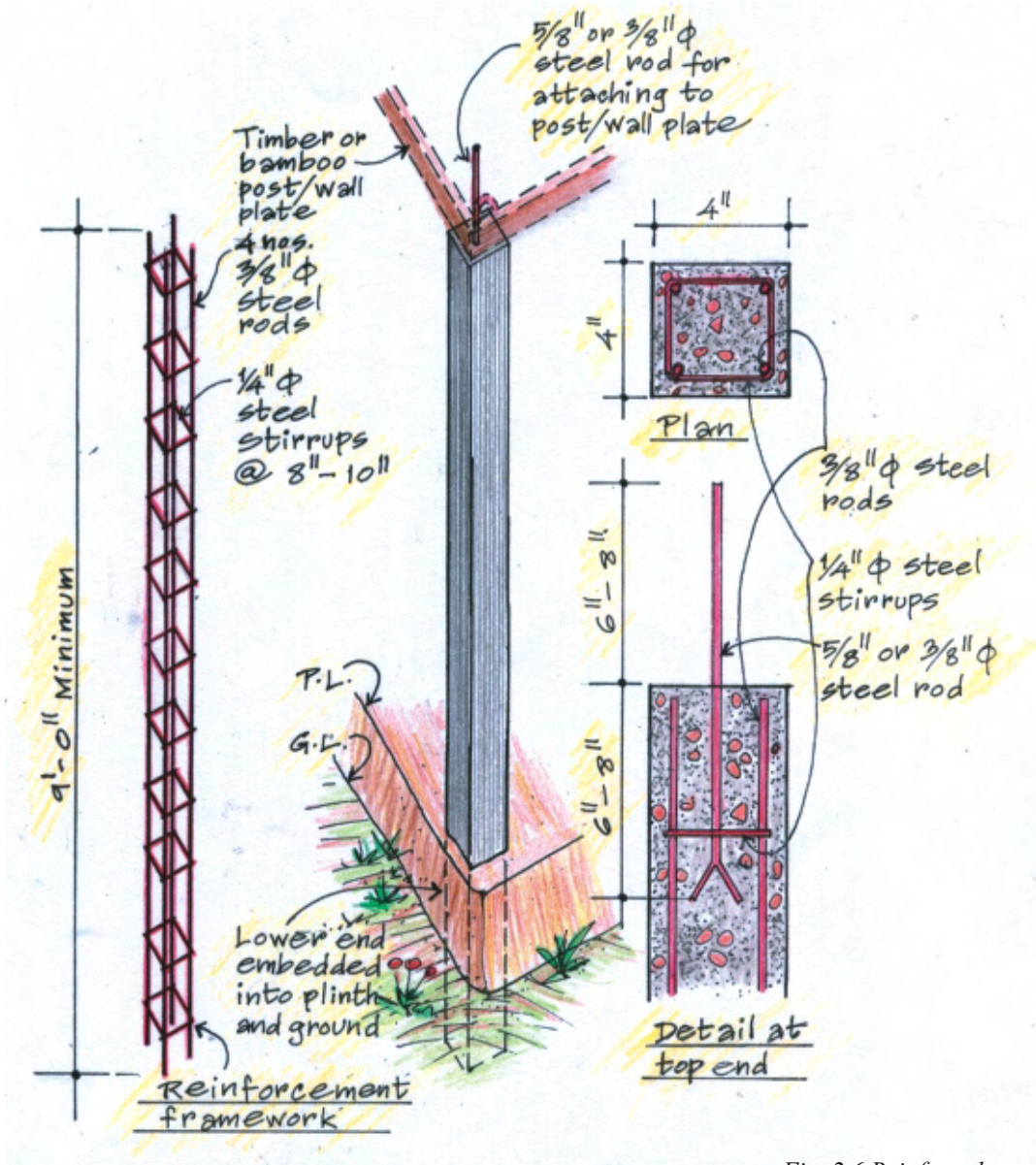

Fig. 2.6 Reinforced concrete post



## 2.3 WALLS

### 2.3.1 Protection Against Rainwater Splashing & Flood

#### 2.3.1.1. Detachable Lower Panels

- Made of cheap, perishable materials such as straw, reeds, rushes or jutesticks.
- Replaced after wet season without affecting upper walls.

#### 2.3.1.2 Painting with Bitumen

- Local damp-proofing method.
- Can be done both on bamboo mat walls and CI sheet walls.
- Molten bitumen, Mobil or sump oil, or a combination of these can be used.
- Provides mainly damp-proofing, does not prevent much insect or fungal attack.

#### 2.3.1.3 Protective Lower Panel (Gorani) & Rain Protector over Door and Gable End (Bhelki)

- Made of CI sheet to protect from water and dampness.
- In houses with gable roof, a triangular *bhelki* at the top end of the wall on the gabled side prevents rainwater penetration.
- Can be painted with bitumen for additional water resistance.
- Local method in some areas which can be promoted for wider use and replicated in other areas.



Fig. 2.7 1. Detachable lower panels  
2. Painting walls with bitumen  
3. Gorani & Bhelki

## 2.3.2 Chemical Treatment of Bamboo Mat Walls

- ❑ Simple chemical preservative treatment methods for increasing the longevity of organic materials have been developed a long time ago.
- ❑ Increases cost by 20-25%, but can increase longevity by more than three or four times. If untreated, bamboo mat walls do not last more than 4-5 years in outdoor conditions, but after treatment lasts for 15-20 years.
- ❑ The chemicals are not harmful if proper precautions are maintained.
- ❑ For chemical preservative treatment of bamboo battens and mats, the simplest method is to build a tank made of bricks and concrete, or at cheaper cost, lining an excavation in the ground with polythene sheet, or cutting a cylindrical metal container (e.g. oil drum) into half and welding them end-to-end (for other methods, see section 3.4).
- ❑ A typical preservative can be prepared to be mixed in the tank in the following proportions: Copper Sulphate 4%, Sodium Dichromate 4%, Boric Acid 2%, Water 90% = TOTAL 100%.
- ❑ The materials should preferably be freshly harvested, but dry ones can also be treated.
- ❑ Bamboo battens and mats are to be first soaked in water for at least 24 hours and then dried.
- ❑ They are then to be immersed completely in the chemical preservative solution for 24 hours.
- ❑ After soaking, the materials are to be raised above the tank and supported on bamboo poles or timber battens so that excess chemicals can drip back into the tank and can be re-used.
- ❑ Then they are to be dried in an open shaded space for 1-2 days and then in sunshine for 3-4 days.
- ❑ Gloves or polythene bag covers to be worn to protect hands from chemicals during the treatment process.

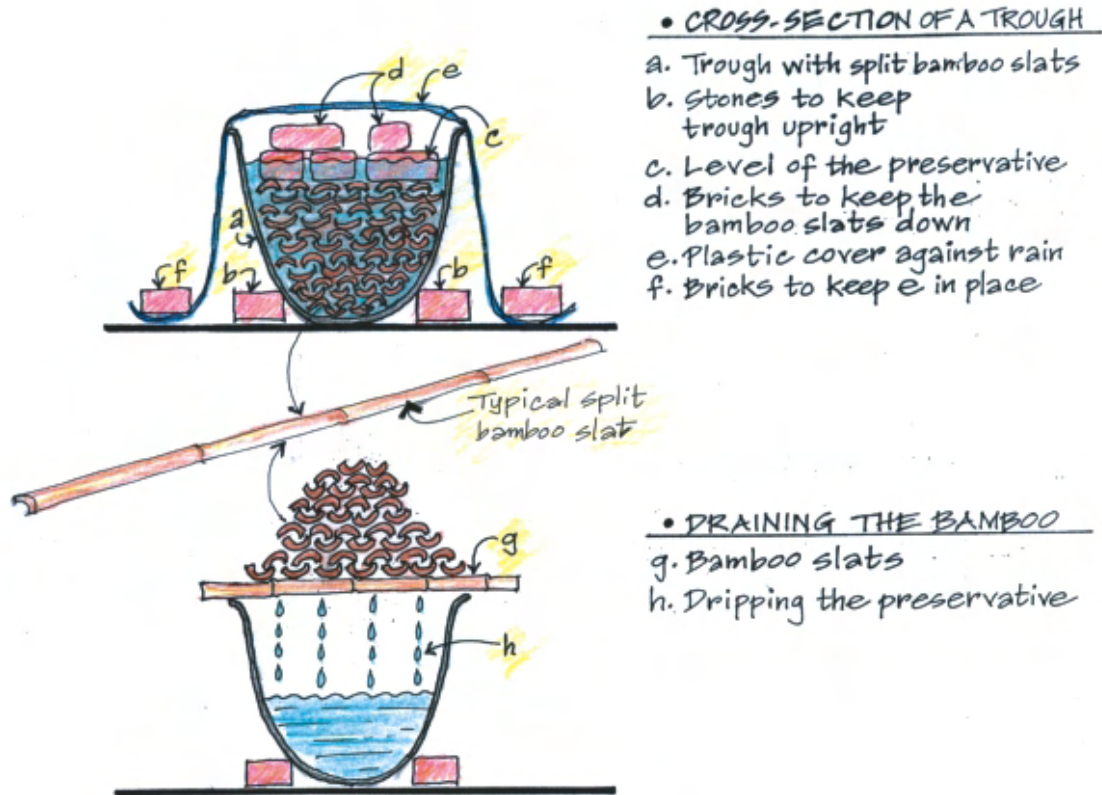

Fig. 2.8 Bamboo treatment by soaking in chemical preservatives  
(adapted from Janssen 1995)

### 2.3.3 Cross-Bracing

- ❑ To increase stability and wind-resistance of the structural frame of bamboo-framed houses, cross-bracing with split bamboo sections should be done.
- ❑ If a house become weakened at its base due to flood, cross-bracing helps to keep the structure stable.
- ❑ Split bamboo sections used for cross-bracing should be treated with chemical preservatives so that they do not decay easily and lose their strength.
- ❑ Instead of jute or coir rope, nylon rope or good quality galvanized wire should be used for tying the elements of the structural frame.

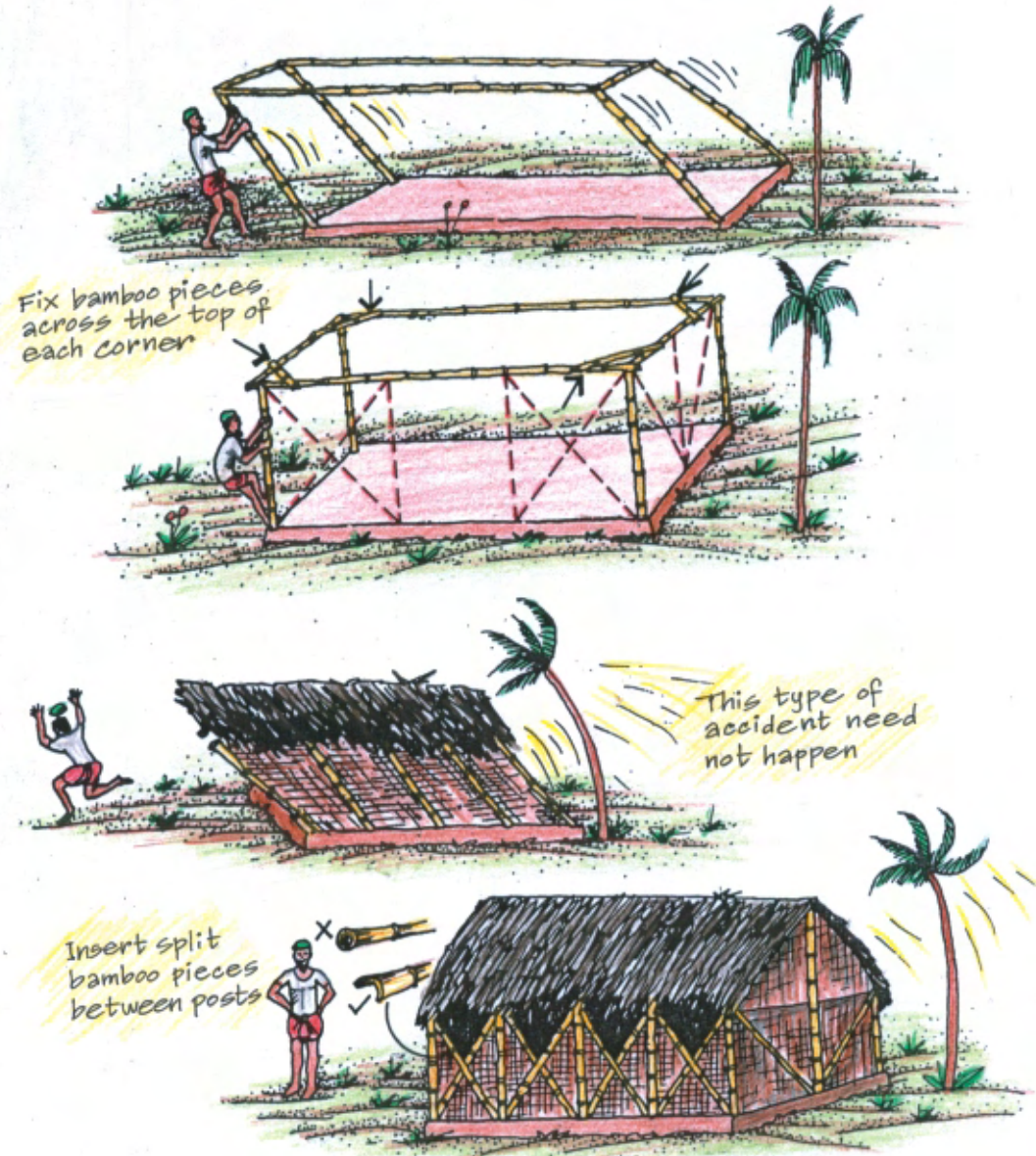

Fig. 2.9 Cross-bracing of bamboo structural frame  
(adapted from Chisholm 1979)

## **2.3.4 Strengthening Earthen Walls**

(see section 4.2 for details)

### ***2.3.4.1 Internal Framework***

- ❑ For areas with heavy rainfall and flood, it is essential for earthen houses to have an internal structural framework.
- ❑ After rainfall or flood recedes, earth cover that may get washed away can be renewed without compromising the structural stability of the house.
- ❑ Framework can be of bamboo or timber which should be treated against decay.
- ❑ Earth to be used as plaster or daubing without serving as structural element. Adding cement to the mud plaster stabilizes it and allows resisting erosion.
- ❑ Fig. 2.10 shows an earthen wall with internal framework of bamboo used typically in Sylhet district. There are many other ways of accomplishing similar effect (see section 4.2.1).

### ***2.3.4.2 Cement Stabilization***

- ❑ Resists erosion by water.
- ❑ Ideal cost saving method for inside walls in buildings with brick outer walls and damp-proof plinths.
- ❑ Processing and preparation of mix similar to that of plinth stabilization (see section 2.1.1).
- ❑ Walls can be built by ramming inside wooden shuttering or by making blocks with a simple brick mold (see section 4.3.1).

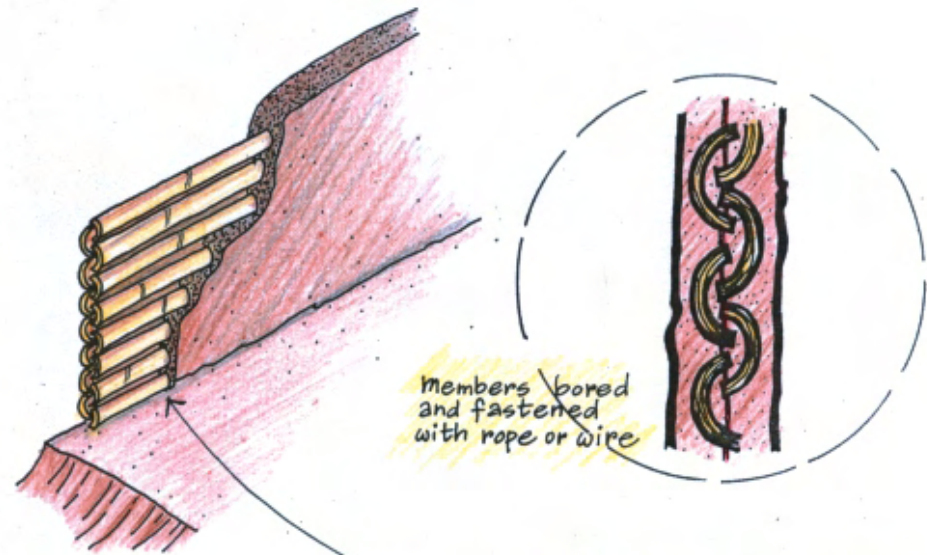

1. Split bamboo members aligned horizontally, then mud-plastered. Bottom member rests on earthen plinth.

2. Split bamboo members aligned vertically, then mud-plastered. Vertical members embedded into earthen plinth.

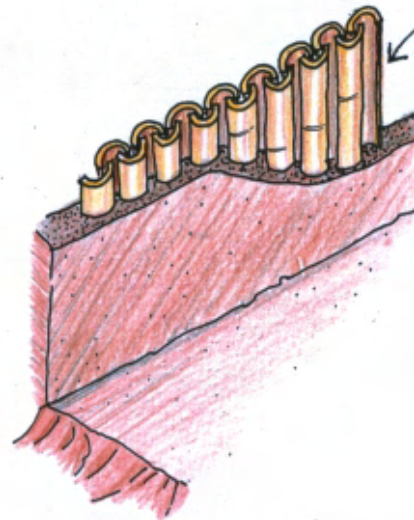

Fig. 2.10:

1. Building a rammed earth house
2. Compressed cement-stabilized bricks
3. Earthen wall with internal bamboo framework

## 2.4 ROOFING

The roof often serves as refuge during flood. Therefore, it is important that the roof is strong and well-built, in addition to use of durable, water-resistant materials and wind-resistant design.

### 2.4.1 Chemical Treatment of Thatch

- Similar to treatment of bamboo mats and battens (see sections 2.3.2 and 3.4.2.1).
- Fibrous thatching material, such as catkin grass, rice straw, palm fronds, wheat, maize or sugarcane leaves needs to be soaked in preservative solution for only 12 hours (bamboo mats and battens 24 hours).



*Fig. 2.11 Treatment of thatching material by soaking in chemical preservatives*

## 2.4.2 Wind-Resistant Roofing

- Protection against wind-hazard contributes to the overall improvement of housing in flood-prone regions.
- Four basic principles should be followed:

### **Aerodynamic roof form:**

- Roof pitch 30°- 40° to reduce effects of suction and uplift.
- Hipped instead of gable roof. If gable, then ends tied down firmly to rest of structure. Lean-to should be avoided.
- Overhang <2' - 6'' , vents in roof and masonry parapet.
- RCC roof provides superior protection, but heavy in earthquake. Need for adequately braced vertical structure.

### **Roof connected to structure:**

- Rafters at recommended spacing.
- Cross-bracing in plane of roof and ceiling, and also for openings, if any. Openings restricted in size.
- Strong connections between roof and vertical structure. Metal straps, bolts with washers on both ends instead of simple nails.

### **Well-fixed roof covering:**

- CI sheet screwed at every corrugation. Tiles fastened individually.
- Use of J-hook bolts and threaded/ twisted roofing nails.

### **Regular maintenance:**

- Should make regular checks, especially around ridge and corners.
- Should replace weakened members, repair loose members.
- CI sheet should be tied strongly to structural frame to resist uplift by strong wind. To further increase wind-resistance, number of purlins should be increased near eaves, ridge and corners.



- Every sheet to be fixed to purlins with hook bolts or twisted nails at each corrugation. More frequent fixings at edges to prevent uplift.
- Adequate connections should be made with nylon rope or good quality galvanized wire (instead of jute rope).
- Roofing elements should be connected properly: purlin to rafter, rafter to wall plate, wall plate to posts.
- Even though more expensive than lean-to (*akchala*) and gable (*dochala*) roofing, hipped roofing (*chouchala*) is more resistant to wind and protects gable end walls from exposure to rain and water penetration.

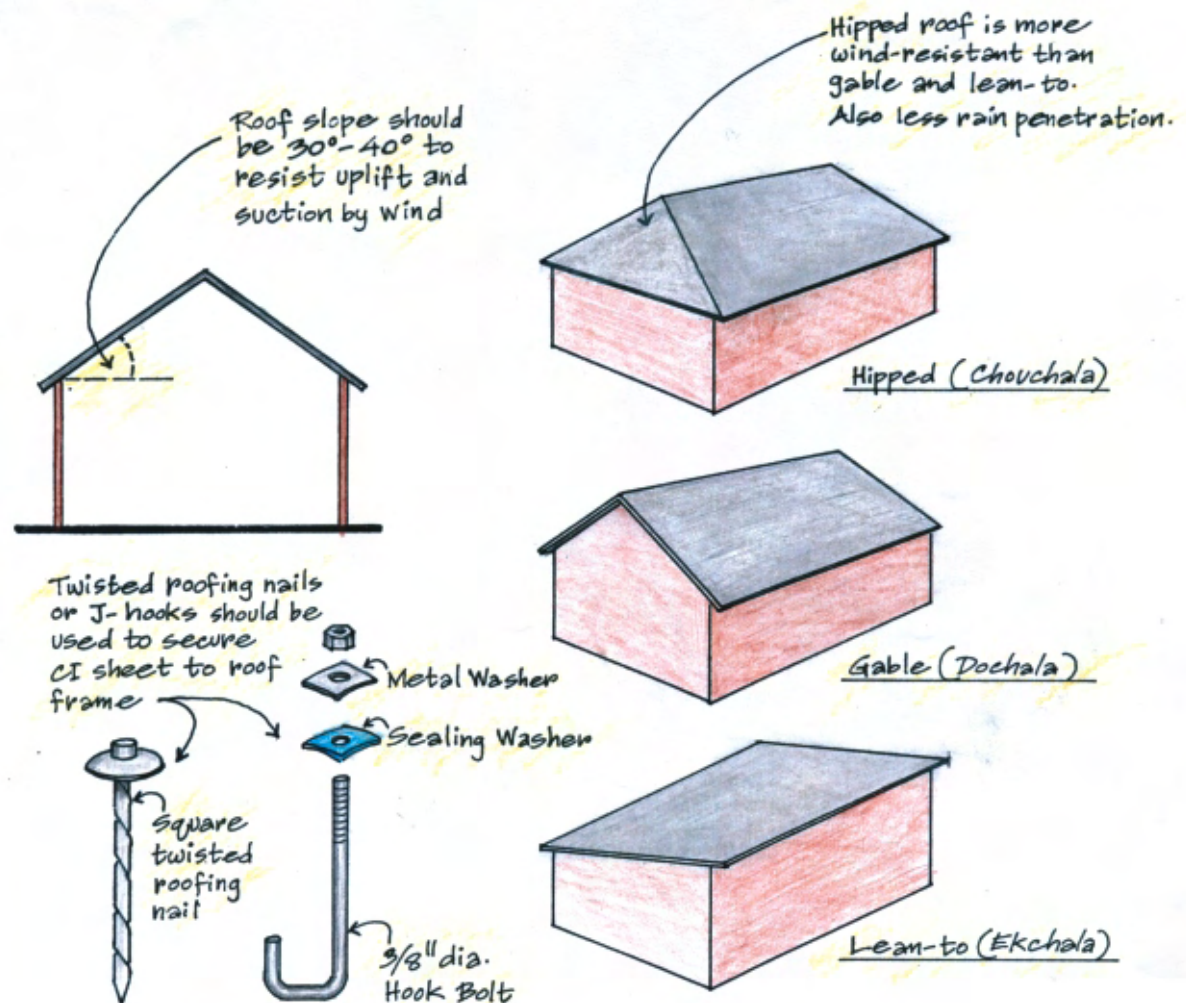

Fig. 2.12 Basic features of wind-resistant roofing  
(adapted from Mayo 1988)

## 2.4.3 Rainwater Gutter

- Rainwater gutters prevent creation of furrows around plinth by rain falling down from roof eaves.
- They also prevent rainwater splashing on walls.
- Arsenic-free rainwater can be collected for household use by keeping a container where the water drains down.
- 4 inch diameter PVC (polyvinyl chloride, i.e. plastic) pipe can be cut into half lengthwise using a saw.
- MS (mild steel) flat bar brackets can be screwed to rafters or wall plate to hold gutter.
- If brackets prove too difficult or expensive to make, GI (galvanized iron) wire or nylon rope can also be used for attaching gutter.

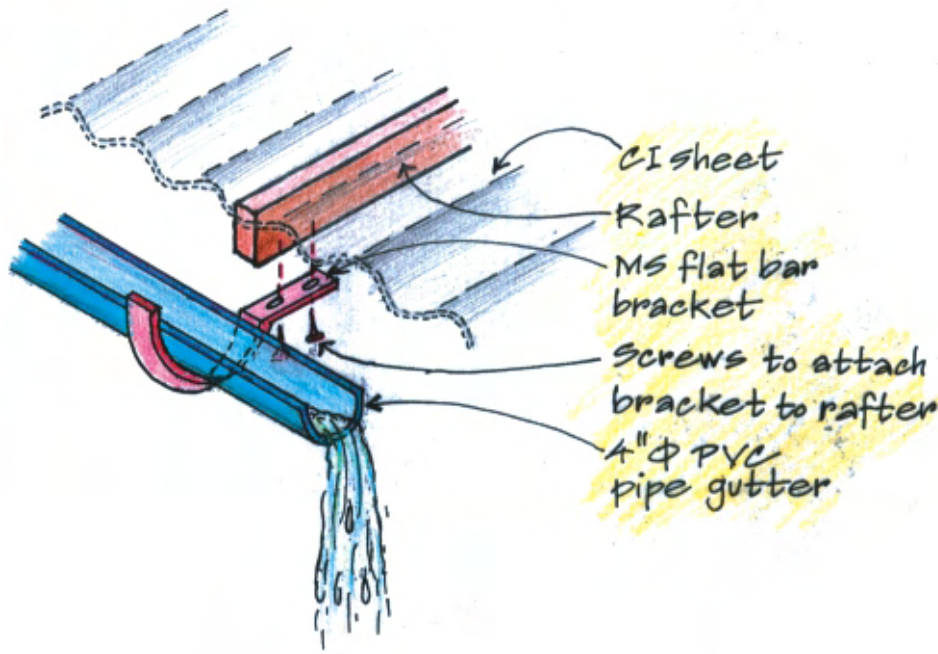

Fig. 2.13 PVC pipe rainwater gutter detail and house being built with a gutter

## Chapter 3

# BAMBOO CONSTRUCTION

### 3.1 CATEGORIES AND USES IN HOUSE CONSTRUCTION

#### 3.1.1 Thick Walled Bamboo Varieties

- Usually grown on village homesteads and plantations.
- Used as supporting elements for walls and roofs where strength is required, such as posts.
- Also used for making battens for structural frames of walls and roof.

#### 3.1.2 Thin Walled Bamboo Varieties

- Usually grown in forests in hilly areas of Chittagong and Sylhet.
- Split and woven into stiff mats for making wall panels and sometimes roofing.



Photo: Yasmin Ara

## 3.2 PROPERTIES

### 3.2.1 Untreated Bamboo

- Lifespan:
- In contact with atmosphere & soil: 1-3 years.
- Under cover: 4-6 years
- Under cover and in less humid climate: 10-15 years

### 3.2.2. Treated Bamboo

- Lifespan can be extended up to 15-20 years even if in contact with humid atmosphere and soil.

### 3.2.3. Causes of Short Lifespan

- When it remains in contact with water or moisture, including flood.
- Particularly weakened if exposed to alternating wet and drying periods, such as in flood.
- When it is attacked or weakened by insects, primarily borers and termites.
- When it rots due to fungal or bacterial action.



*Fig. 3.1 Bamboo post under insect attack*

## 3.3 TRADITIONAL BAMBOO TREATMENT

- ❑ Cheaper compared to chemical preservative methods, but less effective.
- ❑ Can be done easily in rural areas without special equipment.
- ❑ Need to be promoted where such practice is declining.

### 3.3.1 Soaking in Water (“Pynot”) -

#### Most Common Practice

- ❑ The culms should be placed in water for around two weeks.
- ❑ Then they are to be dried for a week (in the shade).
- ❑ By leaching, this process eliminates the nutrients (starch) sought after by bamboo borers.
- ❑ Does not retard termite infestation.

### 3.3.2 Clump Curing

- ❑ Cut bamboo should be stacked vertically for a few weeks after felling, with branches and leaves intact.
- ❑ Such bamboo continues to live off its reserves and hence reduces starch content and thereby insect attack.
- ❑ Does not retard termite infestation.

### 3.3.3 Seasoning

- ❑ This should be done by drying bamboo in the open, under cover, with as much air movement as possible.
- ❑ It can take a couple of months.

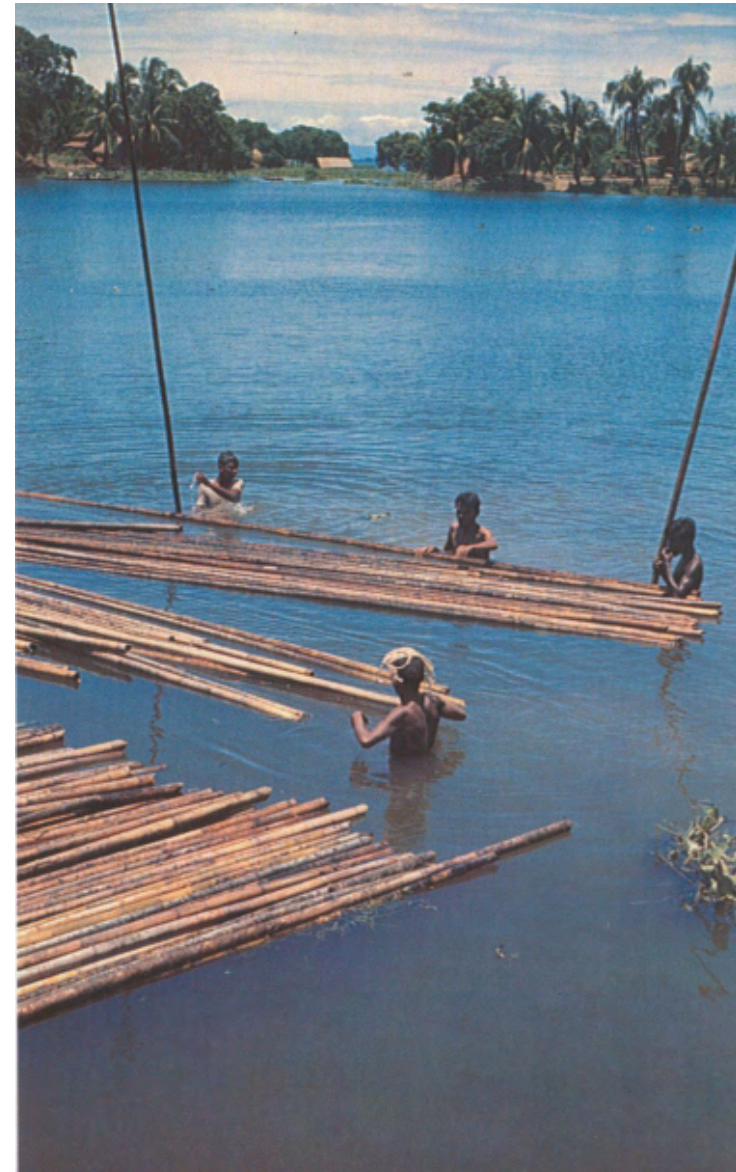

Fig. 3.2 Bamboo treatment by soaking in water (“pynot”) (photo: Barker 1994)

## 3.4 CHEMICAL PRESERVATIVE METHODS

- For the basic form of chemical treatment, refer to section 2.3.2.
- A highly effective treatment method of bamboo poles is the “boucherie” process, but since it needs special equipment, it has not been discussed here. There are many publications on the topic and if necessary those can be referred to.
- Very important to remember safety measures for chemical preservative treatment. Basic measures:  
A) Gloves or plastic bag covers should be worn on hands. B) Avoid getting into the eyes. C) Keep children and animals away during processing. D) Discard used chemicals in designated waste areas.

### 3.4.1 Chemical Preservative Types

#### *3.4.1.1 CCA (Copper-Chrome-Arsenic Composition)*

- Mixture should be prepared in the proportion 3:1:4 (copper sulphate : sodium dicromate: arsenic acid) .
- Because of the use of arsenic, the mixture is toxic, so should be applied with care using gloves or plastic bag covers on hands.
- CCA once dried remains fixed within the bamboo material and there is then no danger of leaching out and causing harm.
- The concentration of the solution in water should be:
  - In contact with atmosphere & soil: 8% - 12%.
  - In contact with atmosphere, not soil: 5% - 8%.
  - Under cover (trusses, purlins, ceilings, etc): 3% - 4%.

### ***3.4.1.2 CCB (Copper-Chrome-Boron) or Boron***

- To be used in 3:1:4 (copper sulphate : sodium dicromate : boron) proportion or only boron can be used, which is a compound of boric acid and borax.
- 10% solution in water where boric acid : borax = 2 : 3 i.e. 2 kg boric acid and 3 kg borax in 45 liters of water.
- CCB is cheaper than CCA and not toxic.
- However, it is difficult to get the mixture completely fixed and there is possibility of leaching out. Should not be used where it is subject to repeated wetting.

### ***3.4.1.3 Oils***

- Mobil, sump oil, diesel, kerosene, creosote (bitumen/tar oil) can be used independently or in combined form.
- Diesel and kerosene are less toxic and insects are repelled by their smell.
- Creosote is toxic, but its characteristics deter misuse; provides water-resistance, but less protection from insect attack.
- Effective if creosote is combined with diesel or kerosene for both water-proofing and prevention of insect attack.

## 3.4.2 Chemical Treatment Methods

### 3.4.2.1 Dip Diffusion Method (also see section 2.3.2)

- ❑ Mixture should be prepared in the proportion 3:1:4 (copper sulphate : sodium dicromate: arsenic acid).
- ❑ Whole or split bamboo culms are cut to size or bamboo mats of suitable dimensions are dipped in chemical solution (preferable CCB or boron) in a tank.
- ❑ Instead of a brick and concrete tank, a simpler tank can be made from oil drums cut in half lengthwise and welded end-to-end. Even cheaper to line an excavation in the ground with polythene sheet.
- ❑ If metal tank, its inside should be painted with bituminous coating to protect from corrosion.
- ❑ During dipping the bamboo should be pressed down with stones or bricks to completely immerse in solution.
- ❑ For whole bamboo culms, a 6 mm hole should be drilled in each node for more effective chemical penetration.
- ❑ Whole bamboo should soak for at least a week, split sections for three days.
- ❑ The tank should be covered with polythene sheet to keep rain out.
- ❑ After soaking, the preservative should be allowed to drain back by raising the treated bamboo above tank on bamboo supports for a few hours.
- ❑ Finally the treated bamboo should dry for 1 week in a rack, protected from direct sunlight and rain.

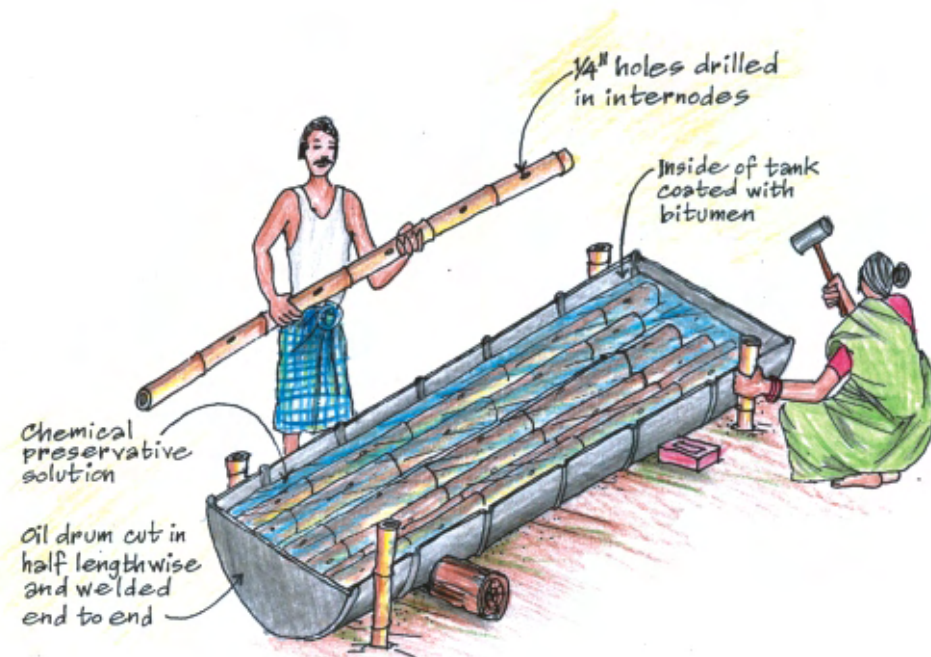

Fig. 3.3 Dip diffusion treatment of whole bamboo culms  
(adapted from: NMBA 2004)



### 3.4.2.2 Internodal Injection Method

- Simple method requiring little equipment.
- 6 mm hole should be drilled in each internode of a whole bamboo culm and 20-50 ml creosote (tar oil/molten bitumen) combined with kerosene/ sump oil/ Mobil/ diesel should be injected with a large syringe.
- Paraffin wax (or putty, if available) should be used to plug the holes.
- The culms should be rolled 2-3 times a day for 7-10 days to distribute the preservative and complete the treatment.
- Treatment method applicable for green or dry culms used for making members exposed to occasional wetting, such as bamboo posts.

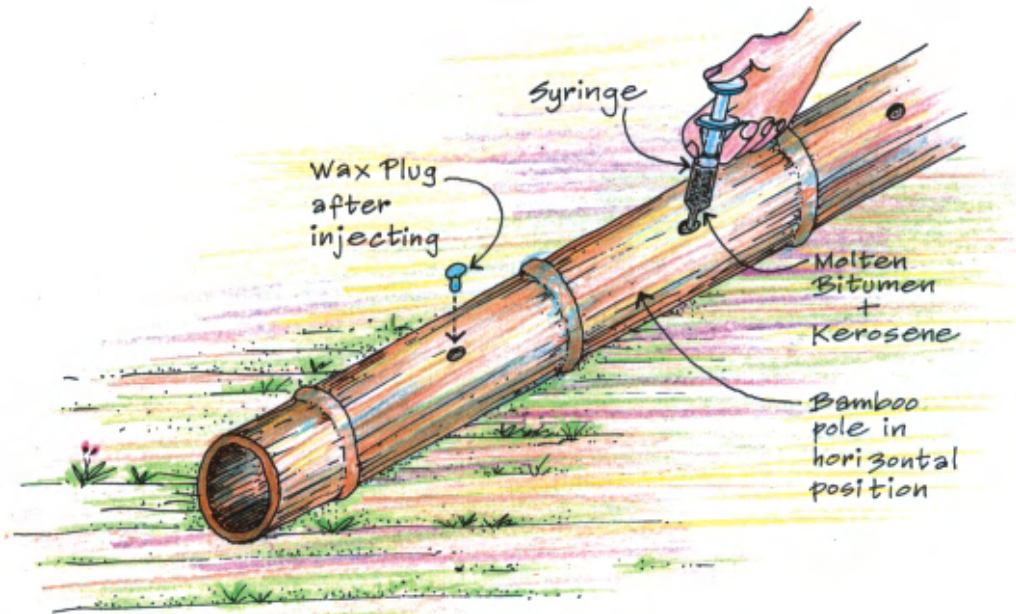

Fig. 3.4 Internodal injection method for treatment of whole bamboo culm

### 3.4.2.3 Hot-and-Cold Method

- Bamboo to be treated should be submerged in tank or oil drum of preservative that is directly heated by fire.
- After a period of maintaining constant temperature, the container should be allowed to cool, when the preservative is drawn into the bamboo.
- This method can be used for green or dry culms.
- 10% boron solution or creosote + kerosene/Mobil/sump oil/diesel should be used as preservative.
- If creosote, should be used to treat lower 600-900 mm ends of several bamboo posts at the same time by immersing in container.
- Should be heated to about 90°C for 3-4 hours and then allowed to cool overnight.



Fig. 3.5 Hot-and-cold method of treating bamboo posts  
(adapted from: NMBA 2004)

## 3.5 DESIGN ASPECTS

### 3.5.1 Keeping Dry

- ❑ Extended roof eaves to be used to prevent direct wetting of walls during rain.
- ❑ Rainwater gutters can be used to discharge water away from the house. Added benefit is arsenic-free rainwater collection.
- ❑ Should build house on raised homestead with slightly sloping ground for drainage.

### 3.5.2 Avoiding Ground Contact

- ❑ Concrete stump (*katla*) (see section 2.2.2) or if affordable, brick plinth should be used to support bamboo posts.
- ❑ Resting bamboo walls on the plinth should be avoided. Better to have a small gap (around 1 inch) between wall bottom and floor. Also allows prevention of termite infestation.

### 3.5.3 Ventilation

- ❑ Roof space should be left exposed to allow better airflow and ventilation.
- ❑ If ceiling is used, it should allow ventilation and should be accessible for maintenance.
- ❑ Adequate number and size of windows should be built, oriented along the prevailing wind flow direction to allow cross-ventilation.

### 3.5.4 Protection from Insects and Vermin

- ❑ Termite shield of galvanized MS sheet or cheaper polythene sheet should be used between bottom of bamboo post and its support, such as concrete stump (*kaatla*) or masonry plinth.
- ❑ Open ends of bamboo posts should be plugged to protect from rodent infestation.

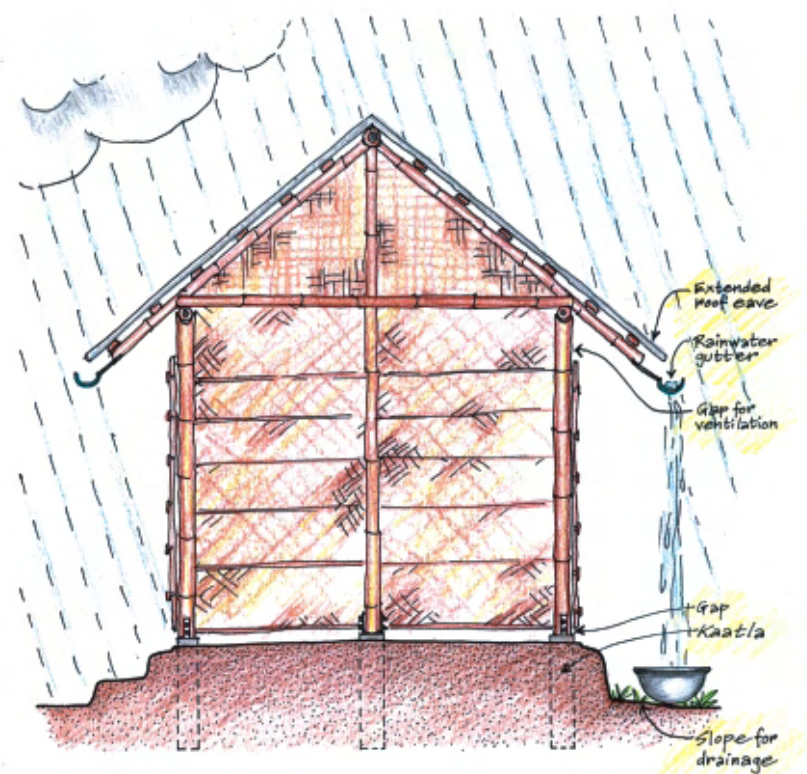

Fig. 3.6 Design aspects of building a bamboo house

## 3.6 ECONOMIC FEASIBILITY OF CHEMICAL PRESERVATIVE TREATMENT

- ❑ Cost of a untreated bamboo house with thatch roof (around 200 square feet) = Tk 5,000
- ❑ Cost of a treated bamboo house of same dimension = Tk 6,250
- ❑ Cost increase due to preservative treatment = Tk 1,250
- ❑ Cost of treatment = 25 % of the cost of untreated house
- ❑ Service life of conventional untreated bamboo house = 7 years
- ❑ Minimum expected service life of treated bamboo house = 15 years
- ❑ That is, **25% increase in cost results in 100% increase in lifespan.**

## Chapter 4 EARTH CONSTRUCTION

### 4.1 LIMITATIONS

- ❑ Despite the wetness of the Bangladeshi context, earthen walled houses are prevalent in many areas. Mostly monolithic type wall construction, but also wattle-and-daub type in some areas.
- ❑ Most such areas are relatively elevated, but in recent years have experienced unprecedented floods, resulting in widespread collapse of houses with earthen plinths and monolithic walls.

#### 4.1.1. Causes of Limitations

##### WATER IS THE GREATEST ENEMY OF EARTHEN HOUSES

- ❑ **Effect of Flood:** Flood water affects the typical earthen plinth, thus weakening the base of walls. Combined with capillary rise of water into the walls, this can result in collapse of the entire house.
- ❑ **Effect of Rain:** Driving rain, especially in houses without sufficiently extended roof eaves, can damage earthen walls severely.
- ❑ **High Maintenance Requirement:** Earthen plinth and walls require regular maintenance, often plastered every week, especially during the wet season. Since household women do this work, it is unaccounted labor and places an extra demand on women who are often overburdened with domestic tasks.
- ❑ **Vermin Infestation:** Various insects, including worms, termites and ants, and also rodents and birds tend to burrow into earthen walls and establish their habitats. This can weaken earthen plinths and walls substantially.



*Fig. 4.1 A traditional earthen house faces various problems - high maintenance, damage by rain and flood, vermin infestation, etc*

## 4.2 REMEDIAL MEASURES

### 4.2.1. Incorporating an Internal Structural Frame

- In flood-prone areas, instead of building monolithic earthen walls which tend to collapse, it is better to build in the wattle-and-daub method, that is, incorporating an internal framework of bamboo, timber or similar material which is plastered with earth.
- In the case of flood or rain which may damage the earth plaster, the framework prevents the house from collapsing and it can be plastered later and repaired.
- Compared to monolithic earthen construction, wattle and daub method allows building thinner and lighter walls requiring less earth material, takes less time to build and does not require specialized labor. An added bonus is its better resistance to earthquake.
- A common wattle and daub type method in many areas is to plaster typical bamboo, jutestick or rushes walls with mud. However, this is susceptible to decay because the earth plaster absorbs water and thereby causes the organic material inside to rot within a short period. Such houses have to be almost rebuilt after a few wet seasons. Even if a sturdy timber or bamboo framework is used, it is also similarly prone to decay and insect attack.



*Fig. 4.2 Wall built in the wattle-and-daub method*

### 4.2.1.1 Basic Guidelines for Wattle and Daub Construction

- ❑ The framework should include structural posts (bamboo, timber or reinforced concrete) to support the roof.
- ❑ The frame should have cross-bracing to increase its sturdiness.
- ❑ In the case of bamboo framework, substantial horizontal members made of larger split bamboo sections or two sections tied together should be used at 3 feet intervals to reduce the size of panels to be filled in with smaller split bamboo sections and earth. This bears the weight of the earth plaster adequately, which can otherwise cause frame distortion and make the plaster fall off.
- ❑ Bamboo or timber slats, battens and posts used for the framework should be treated against decay and insect attack (refer to sections 2.3.2 and 3.4).
- ❑ Earth used for plastering should be stabilized with cement (refer to section 4.2.2 on stabilization).
- ❑ Instead of jute or coconut coir rope, good quality galvanized wire or nylon rope should be used for tying together the elements of the framework.
- ❑ Wattle and daub walls should be built on a solid plinth, at the least of stabilized earthen capping.

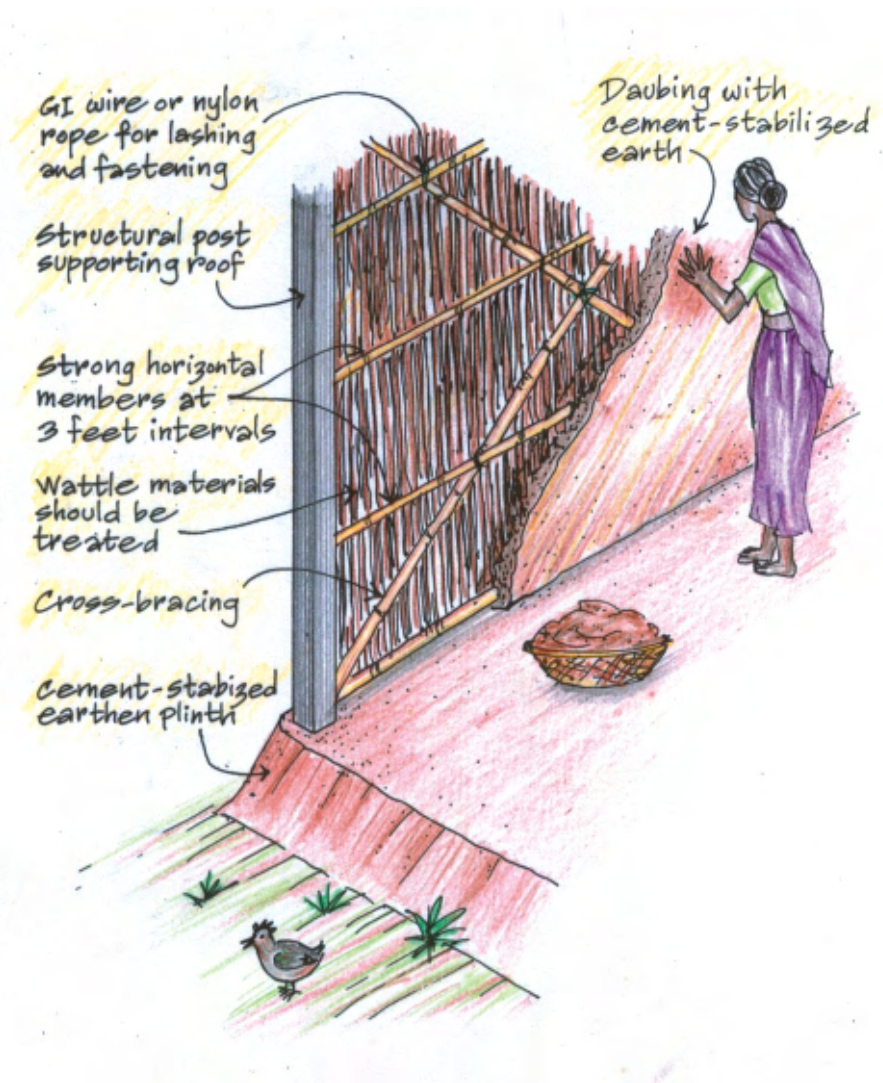

Fig. 4.3 Guidelines for wattle-and-daub construction



### 4.2.1.2 Double Layer Framework with Earth Infill

- Improved and stronger variation of wattle and daub where earth is packed in between two retaining frameworks.
- Load-bearing structure of bamboo or timber posts to support the roof should be built on a solid plinth (at least of stabilized earth capping).
- Horizontal and diagonal bamboo slats should then be nailed on either side of the posts.
- Spacing of vertical posts depends on width of bamboo slats: 1½ inch slats require posts at 1 foot center to center with 2½- 4 inch gaps between the slats; for stronger slats of 3-4 inch, posts can be at 2½- 3 feet distance.
- The space between the frameworks should then be filled with earth (preferably cement stabilized) by hand in lumps and packed down tightly so that it pushes out between the slats.
- Walls should generally be around 6-8 inch thick.
- Small brick chips and/or gravel can also be included into the earth mixture.
- The surface may or may not be plastered. If plastered, stabilized earth mixture of the same proportion as the wall material, but wetter, should be used.
- Instead of jute or coconut coir rope, good quality galvanized wire or nylon rope should be used for tying together the elements of the framework.
- Because the slats are close to the wall surface, they can be replaced when damaged without having to dismantle the wall.

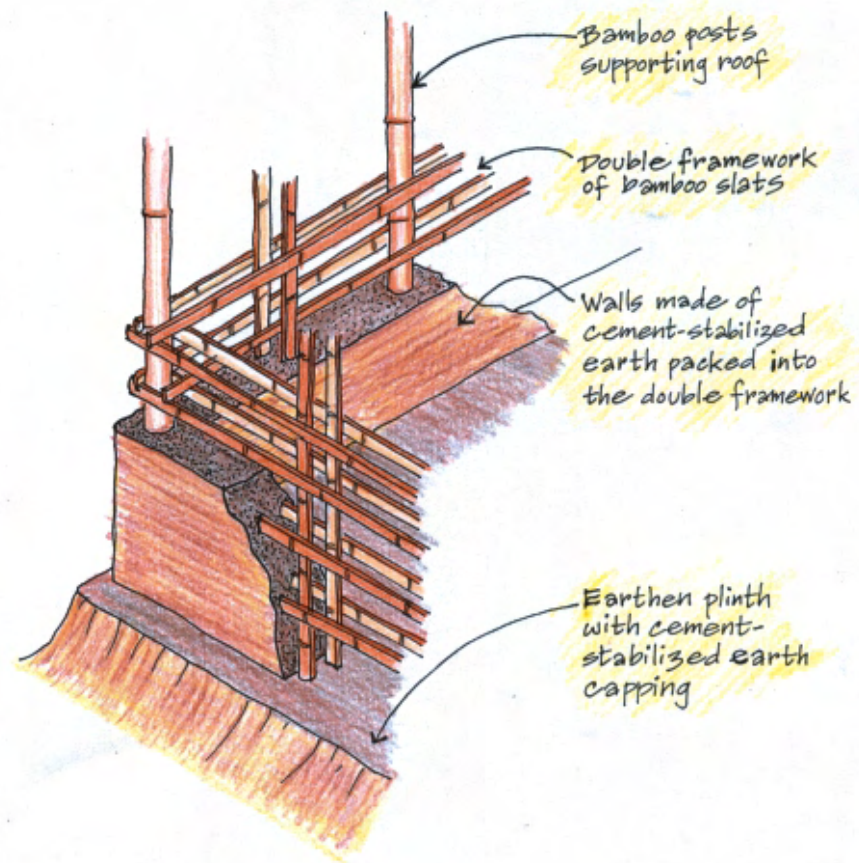

Fig. 4.4 Construction of wall with double layer framework and earth infill (adapted from Norton 1986)

## 4.2.2. Stabilization with Cement

- Mixing a small amount of ordinary Portland cement to earth greatly increases its resistance to water. This process is known as stabilization.
- Lime can also be used, but requires more quality control, therefore it has been chosen here to recommend cement, which is now widely available in most areas.
- Together with the addition of cement, stabilization works best if the earth is also compacted.

### 4.2.2.1 Soil Selection

- Cement stabilization is suitable for soil that has low clay content, that is, it should be composed of larger sandy particles.
- Soil with less than 40% sand content cannot be satisfactorily compacted and stabilized. With such soil, sand has to be added until its composition is suitably modified.
- *Soil with more than 40% sand content can generally be stabilized with 5% cement by volume.*

### OPTIMUM SOIL COMPOSITION

<i>Particle Type</i>	<i>Size (mm)</i>	<i>%</i>
Fine Gravel	2.00 - 4.00	7
Sand	0.02 - 2.00	53
Silt	0.002 - 0.02	20
Clay	below 0.002	20

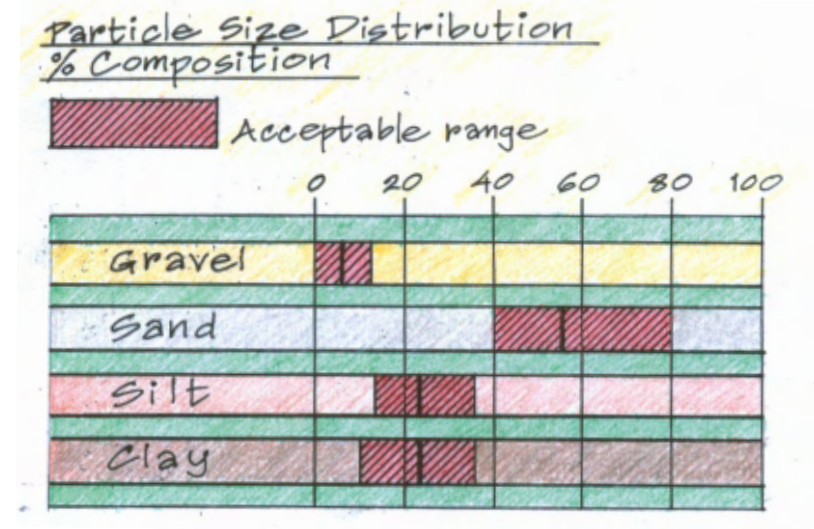

*Adapted from Development Alternatives (undated)*

### 4.2.2.2 Soil Identification

- Ranging from simple field methods to complex laboratory testing, there is a variety of techniques for identifying soil composition for compaction and stabilization.
- For the purpose of this handbook, a basic test is described here which can easily be carried out in the field without special equipment.

### SEDIMENTATION TEST

- A transparent cylindrical jar (or tumbler) of at least 500ml should be filled with soil  $\frac{1}{4}$  of its height.
- It should then be filled up with water, its mouth sealed and shaken thoroughly.
- After that it should for kept still for 1 hour, then shaken again and left to settle.
- 45 minutes later the height of sedimented gravel, sand and silt should be noted.
- 8 hours later the height of sedimented clay should be noted.
- Then the percentages of each layer can be calculated.
- If clay is higher than 30% and sand is less than 40%, extra sand has to be added to achieve the optimum soil composition outlined in the preceding section.
- The sedimentation test has to be carried out until it is noted that the optimum composition has been achieved.

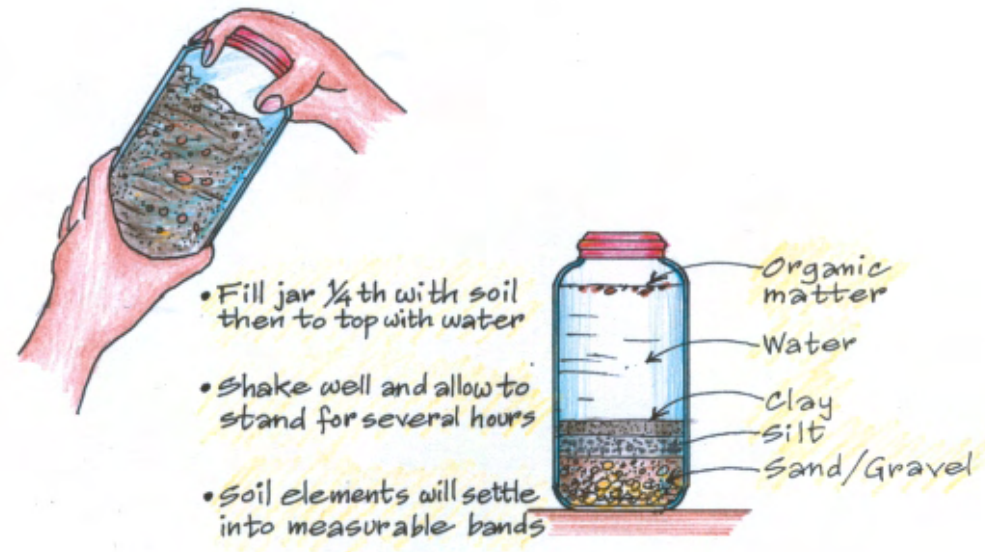

Fig. 4.5 Sedimentation test for soil identification  
(adapted from Berglund 1986)

## 4.3 STABILIZED EARTH CONSTRUCTION METHODS

- Preparation and processing of earth and construction method of cement stabilized plinth has been described in section 2.1.1. Here methods for construction of stabilized earth walls is discussed.
- Stabilized earth can be used in wattle and daub construction and other earth construction methods such as the traditional hand-compacted layering method. The results of these methods can be improved in terms of water resistance by cement stabilization, following the basic principles of preparation, processing and construction as outlined in section 2.1.1. However, to achieve better compaction and hence better water resistance, the methods discussed below are more suitable.

### 4.3.1 Compressed Earth Blocks

- There are a variety of presses for producing compressed earth blocks ranging from manual to motorized ones, but these are mostly uncommon in Bangladesh. Therefore the most suitable method would be to use a simple wooden brick mold operated by hand pressure, which is widely available for brick production.
- Necessary soil selection and identification should be carried out. If the soil has less than 40% sand, extra sand should be added. The soil should be finely crushed, if necessary using a sieve, removing all debris and organic materials from it.
- 5% cement by volume to be added to the processed soil, using a typical 1 cubic foot wooden box. Mixing should be done in dry state and the mix then slightly moistened, taking care not to add too much water.
- Small batches of mix should be prepared and each batch used up within 15-20 minutes to make blocks using the brick mold.
- The blocks should be stored in shade or under cover and moistened frequently for curing at least for two weeks.
- When laying the blocks, mortar of the same mix as used in the block should be used, but using more water. A small amount of lime can be added to prevent shrinkage cracks.

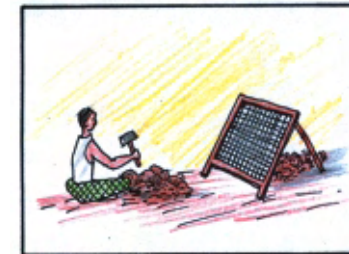

Soil should be crushed and sieved through a screen. Debris and organic matter should be removed.

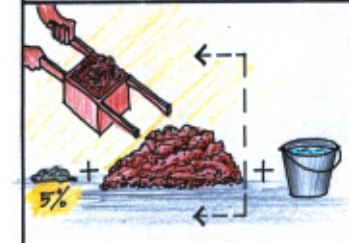

5% cement by volume should be mixed with earth in dry state. After mixing thoroughly, water should be added to make a paste-like mixture.



Soil-cement mix to be placed in wooden brick mold and compacted by hand.



Cover of brick mold to be placed and hand pressure applied to form stabilized earth block.

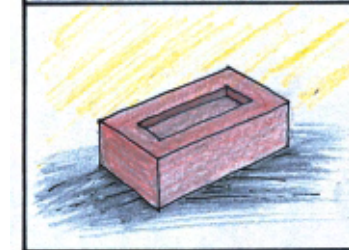

Compressed cement stabilized earth block with frog for effective bonding.

Fig. 4.6 Compressed earth blocks

1. Brick mold used for making earth blocks
2. Rural building made with stabilized earth blocks produced by using a typical brick mold. Note the building in the foreground made of monolithic earthen walls, which are not faring so well
3. Production process of compressed earth blocks

### 4.3.2 Rammed Earth

- This is a system of building earthen walls by compacting soil within forms.
- Typically, wooden forms are used, but steel forms can also be used. For the purpose of this handbook, wooden forms are being recommended because they are less expensive, more easily available and easier to use in rural areas.
- The simplest way to keep the forms in place is to tie them with ropes, but for better control wooden or metal ties can be used. However, the choice of ties depends on the quality required or possible in a certain place and the level of skill.
- Walls should be built in layers, re-using the forms for each layer, packing and compacting the soil within the forms using a hand-held tamp or rammer, or if that is not available, using strong wooden battens.
- The more one compacts, the stronger the wall becomes, but this has to be done in accordance with availability of suitable soil and affordability. More compaction requires more soil and more labor, so an optimum level of compaction has to be decided by the house builder according to availability of resources.
- Soil for rammed earth construction should be stabilized with cement for water resistance. The processes of soil selection and identification, preparation, mixing, casting and curing discussed in preceding sections should be followed.

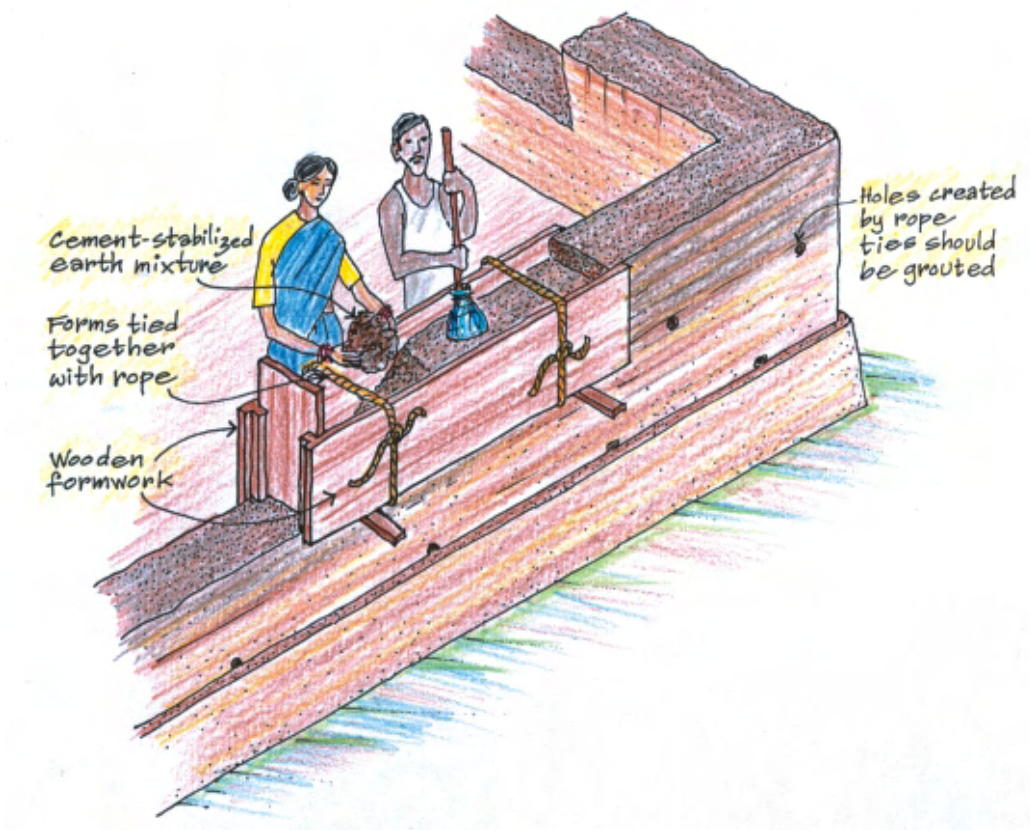

*Fig. 4.7 House being built in Dinajpur using the rammed earth method and construction process of rammed earth wall*

## 4.4 DESIGN ASPECTS

### AN EARTHEN HOUSE NEEDS A GOOD HAT AND GOOD SHOES

#### 4.4.1 Roofing

- ❑ Extended roof eaves should be used to protect earthen walls from rain.
- ❑ Rainwater gutters should be used to discharge water away from the house. Added benefit is arsenic-free rainwater collection.
- ❑ Roof should be supported on posts instead of earthen walls.

#### 4.4.2 Foundation and Plinth

- ❑ Whenever possible, earthen walls should be built on a brick and concrete foundation and plinth.
- ❑ If brick and concrete proves unaffordable, effort should be made to build a raised cement-stabilized earthen plinth.
- ❑ If the foundation and plinth is not of brick and concrete, monolithic load-bearing earthen walls should not be built. In that case, walls should have an internal structural framework or built as infill non-load-bearing walls between posts.
- ❑ Should build house on raised homestead with slightly sloping ground for drainage.

#### 4.4.3 Ventilation

- ❑ Basic principles for good ventilation should be followed – exposed roof space, accessible loft space and adequate windows oriented to make use of prevailing wind flow direction.
- ❑ Adequate ventilation is essential for earthen houses, otherwise leads to dampness which can weaken the structure.

#### 4.4.4 Protection from Insects and Vermin

- ❑ Cement-stabilized earthen construction deters insects and rodents from burrowing and building habitats.
- ❑ Termite shield should be used if walls are not load-bearing and do not require connection to the plinth.



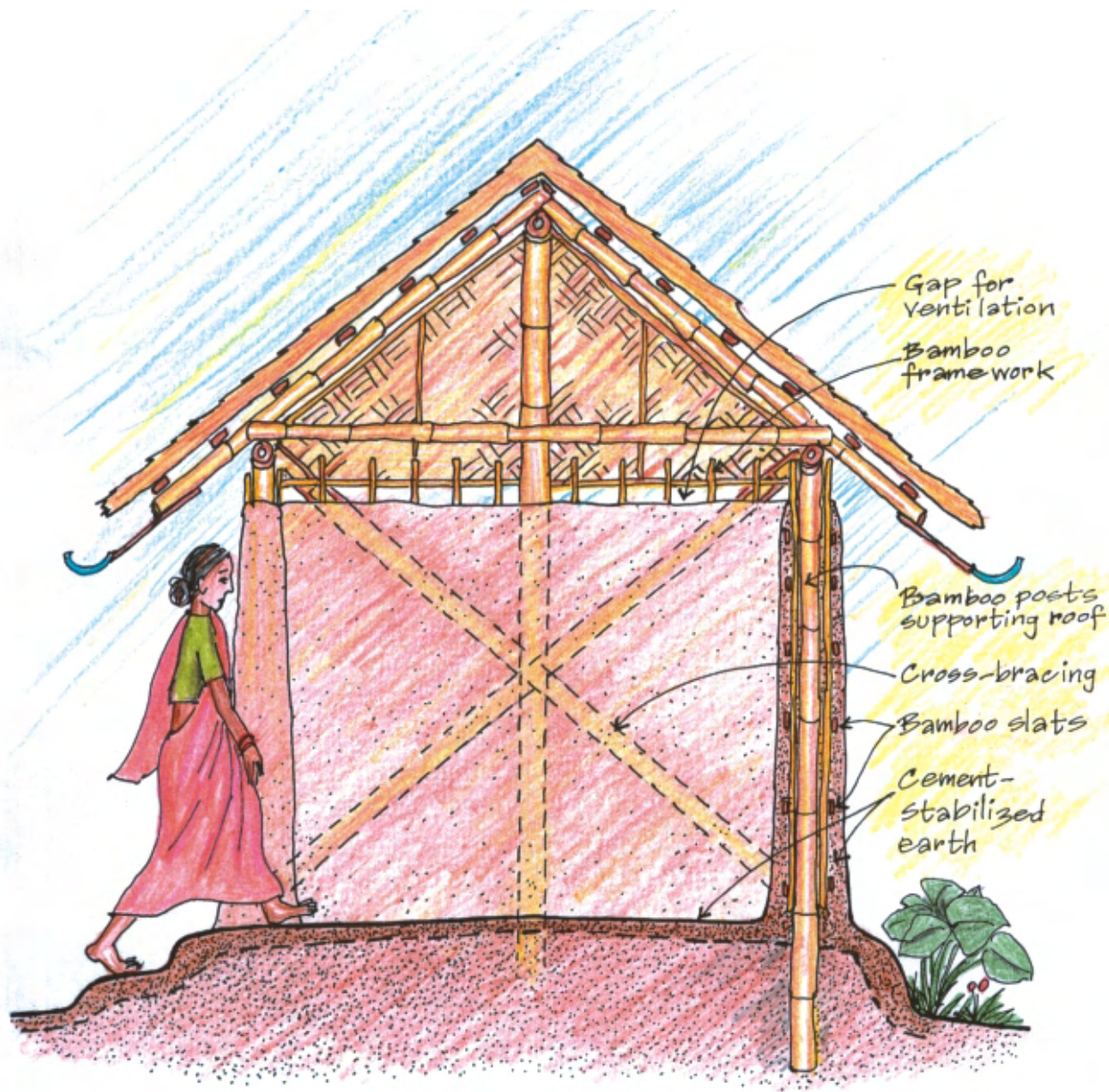

Fig. 4.8 Design aspects of building an earthen house

## 4.5 ECONOMIC FEASIBILITY OF CEMENT-STABILIZATION

- Estimate for a rural house of 10 feet x 15 feet (150 square feet or sft) with average wall thickness of 10 inch and wall height of 7 feet from plinth level.
- Volume of walls =  $2 \times (10 \times 7 \times 0.83) + 2 \times (15 \times 7 \times 0.83) = 290.5$  cft (cubic feet). With 15% deduction for openings = 250 cft (rounded off).
- Cost of each truckload (175 cft per truck) of earth = Tk 500. Therefore,  $1\frac{1}{2}$  truckloads required for wall construction. Assuming  $\frac{1}{2}$  truckload extra for wastage and compaction, total cost of earth for wall construction =  $2 \times 500 = \underline{\text{Tk 1000}}$ .
- Volume of cement required for stabilization = 5% of 250 cft = 12.5 cft.
- Number of cement bags required @ 1.25 cft per bag =  $12.5/1.25 = 10$
- Cost of cement required for walls @ Tk 250 per bag =  $10 \times 250 = \underline{\text{Tk 2500}}$ .
- In an action research project, for a house of  $7\frac{1}{2}$  feet x  $15\frac{1}{2}$  feet (i.e. 116.25 sft) 2 truckloads of earth were required for plinth construction. Therefore cost of earth for plinth construction =  $2 \times 500 = \underline{\text{Tk 1000}}$ .
- 2 bags of cement were required for capping the plinth with stabilized earth. Therefore, for a 150 sft house,  $2\frac{1}{2}$  bags would be required.
- Cost of cement required for plinth stabilization @ Tk 250 per bag =  $2.5 \times 250 = \underline{\text{Tk 625}}$ .
- Total cost of earth required (walls + plinth) = Tk 1000 + Tk 1000 = Tk 2000.
- Total cost of cement required (walls + plinth) = Tk 2500 + Tk 625 = Tk 3125.
- *Increase of cost because of cement stabilization is more than 150%, but its feasibility should not be seen only in apparent cost increase. It is still much less expensive than pucca construction (brick and concrete) and greatly increases flood resistance. Over the long term, cost savings would be realized due to reduced maintenance and labor for regular repair of earthen houses, especially after floods.*

## Chapter 5 INNOVATIVE AND ALTERNATIVE METHODS

### 5.1 CONCRETE

- Use of concrete, particularly reinforced concrete (RC), is very limited in rural areas mainly because of its cost.
- Nonetheless, some concrete components are used in rural houses depending upon availability, which improve their strength (see sections 2.2.2 and 2.2.3) and performance, and here innovation to those components are discussed.

#### 5.1.1. Hollow Concrete Stump (*Kaatla*)

- For those who can afford them, concrete stumps (*kaatla*) are used in rural houses to protect the lower end of bamboo/ timber posts, as discussed in section 2.2.2.
- It is possible to reduce cost by 10% by making the *kaatla* partially hollow. Space can be filled with sand/ earth before placing in the ground and strength is not compromised.
- The concrete mix remains the same as in a solid *kaatla* and fabrication is similar using wooden formwork and casting in horizontal position on the ground. However, to make hollow, the following process is to be followed:
- Polythene sheets to be spread on the ground and a 2-sided wooden shuttering placed.
- For each *kaatla*, at one end a 10-12 inch long  $\frac{1}{4}$  inch MS flat bar clamp and in the other a 2 inch diameter (outer) PVC pipe lubricated with sump oil to be placed in position according to dimensions specified in Fig. 5.1.
- Casting is to be done with a 1:4:4 (cement : sand : aggregate –  $\frac{1}{2}$  inch brick chips) mix to make 4 inch x 5 inch x 2 feet *kaatla*.
- Few hours after casting, the PVC pipe is slowly drawn out, leaving a part of the *kaatla* hollow.
- At least 3 weeks curing by water is necessary.
- To prevent rust, the MS clamps can be painted with molten bitumen.
- For efficient use of wooden shutters, better cost-effectiveness and production, it is advantageous to produce a number of *kaatlas* together.

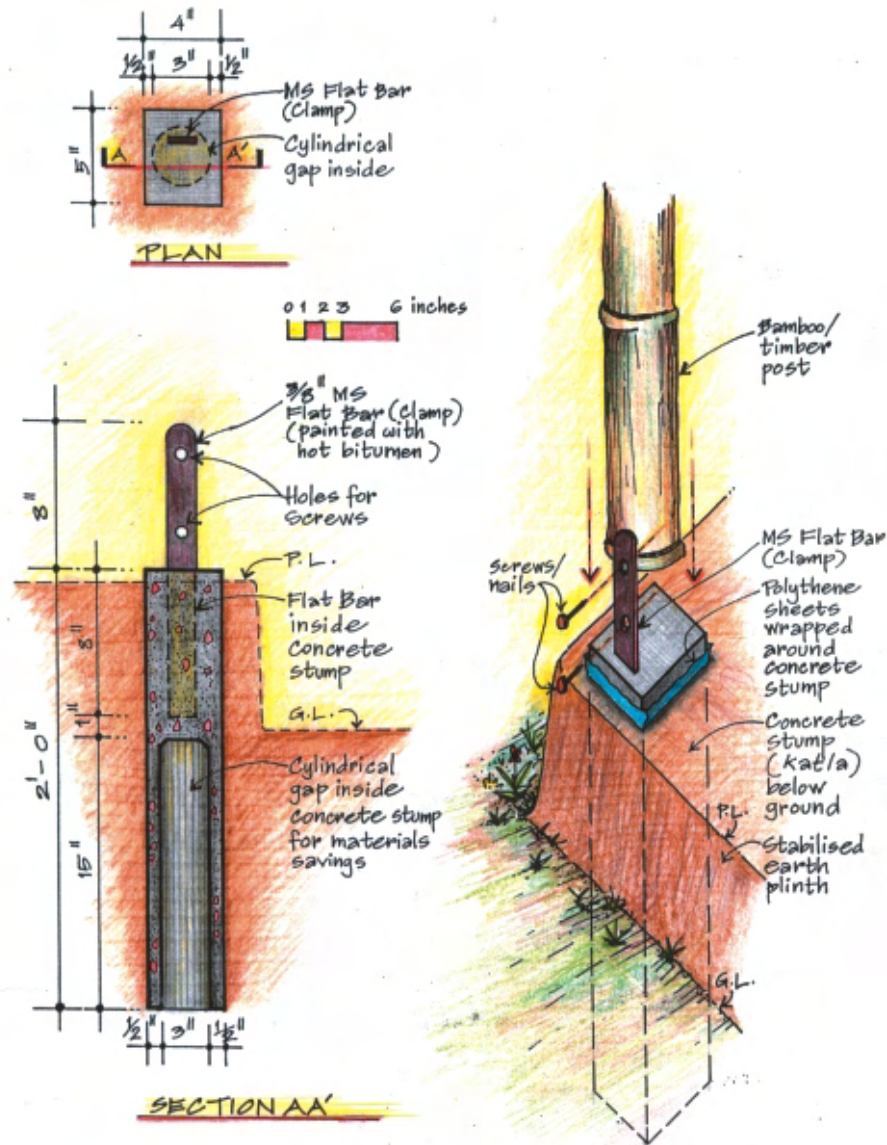

Fig. 5.1 Details of hollow kaatla and its production

## 5.1.2. Hollow Cylindrical RC Post

- RC (reinforced concrete) posts have become increasingly popular as a flood-resistant building product in rural areas and although relatively expensive, they are used by those who can afford them.
- In section 2.2.3, details of RC posts are discussed. Here an innovative method to improve upon the characteristics of regular RC posts is discussed.
- RC posts can be made cylindrical and hollow, somewhat akin to a pipe, instead of the usual solid square section type, yet retaining the flood-resistant properties. This has the following advantages:
  - ▲ Lighter and hence easier to transport and handle; 30-40% less expensive because of materials savings; Better hand grip because of cylindrical shape; No corner chipping, a common problem in regular RC posts.
- However, there are some disadvantages:
  - ▲ It is more difficult to make; Production requires training and quality control.
- These disadvantages could be overcome through long-term promotion for wider popularity so that the product becomes assimilated and the production process is understood at the level of the local building materials producer.
- Basic aspects of production process:
  - ▲ Concrete mix = 1 : 4 : 6 = Cement : Sand : Aggregate ( $\frac{1}{2}$  inch brick chips).
  - ▲ 4 nos.  $\frac{3}{8}$  inch steel rods with stirrups @ 16 inch spacing.
  - ▲ 10 inch long half-cylindrical MS form to be used for achieving shape by sliding.
  - ▲ Cast in horizontal position on ground with polythene sheet below. Top surface shaped and allowed to set for an hour, then rolled over and other surface shaped.
  - ▲ PVC Pipe lubricated with Mobil/grease used for creating hollow. Taken out carefully a few hours after casting.
  - ▲ Cured in shade for at least 3 weeks by covering with jute sacks and wetting frequently.

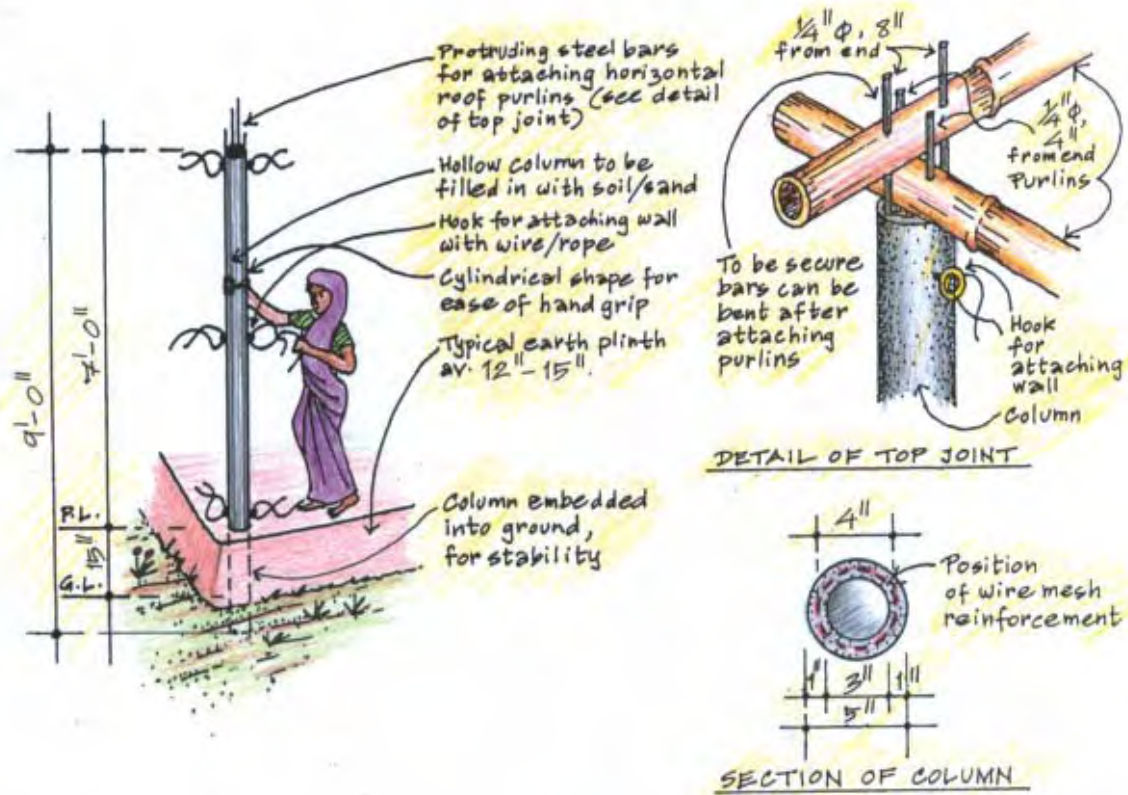

Fig. 5.2 Details of hollow RC post and its production

## 5.2 FERROCEMENT

- ❑ Type of reinforced mortar in which closely spaced and evenly distributed thin wire meshes (welded or woven) are filled with rich cement-sand mortar.
- ❑ Structures can be constructed in any desired shape and thickness, as thin as 1 inch, without formwork.

### 5.2.1 Advantages

- ❑ High crack resistance and *impermeability to water*.
- ❑ Basic raw materials are widely available.
- ❑ Construction skills can be easily acquired.
- ❑ No involvement of complex equipment, heavy plants or machinery.
- ❑ Can be easily repaired and requires little maintenance.



Fig. 5.3 House made of ferrocement wall and roofing panels



Fig. 5.4 Ferrocement construction process  
(photo: IFIC)

## 5.2.2 Materials

- **Cement:** Ordinary Portland cement. Should be clean and fresh.
- **Sand:** Fine and free of impurities and organic materials.
- **Aggregate:** Brick chips screened and downgraded to  $\frac{3}{8}$  inch nominal size.
- **Wire mesh:** Hexagonal (chicken mesh) is commonly used, but can also use other types such as square welded or woven. For square type, wire diameter = 1.3 mm (18 gage) and spacing =  $\frac{1}{2}$  inch. Should be galvanized.
- **Skeletal steel:** Used for making a structural frame over which mesh is placed.  $\frac{1}{4}$  inch,  $\frac{3}{8}$  inch or  $\frac{5}{8}$  inch steel rods depending upon the size of structure.
- Split bamboo sections: Can also be used to make structural frame instead of steel. However, these should be treated to prevent decay (see sections 2.3.2, 3.3 and 3.4).
- **Tying wire:** Soft (annealed) galvanized wire = 24 or 26 gage.
- **Water-proofing chemicals and Paint coating:** Optional



Fig. 5.5 Basic materials for ferrocement  
(photo: IFIC)



### 5.2.3 Construction Methods

- Here the construction method for only ferrocement walls are discussed because of its relevance in the context of flood and ease of construction even in rural locations. Construction of ferrocement roofing elements, which are relatively more difficult to make and install, are not discussed.
- Skeletal steel rods are to be tied together with wire to form a cage-like structure. Spacing and rod diameter is determined by length and height of unsupported span. As a general guide, 12 inch spacing can be used; vertical rods can be  $\frac{3}{8}$  inch and horizontal ties can be  $\frac{1}{4}$  inch. Instead of steel, treated bamboo sections can also be used, which is much less expensive.
- Wire mesh is to be attached by wire to both sides of the skeletal framework, tying at each junction of the skeletal rods.
- Cement and sand to be mixed in dry state in the proportion 1:2 by weight. For construction of stronger walls, the mix should be cement : sand : aggregate = 1 : 2 : 3.
- 0.4 (or 0.45 for mix with aggregate) part water by weight to be added and wet mix to be prepared.
- Small batches of mix to be prepared and used up within  $\frac{1}{2}$  hour to avoid hardening before construction.
- Plastering to be done using simple equipment shown in Fig.5.6.
- One worker to impregnate mortar from one side while another worker holds a back-up sheet on the other side.
- Excessive mortar build-up to be scraped off.
- Curing to be carried out for 28 days preferably in shade to avoid cracking by keeping moist by frequent wetting, covering with jute sacks that retain water.

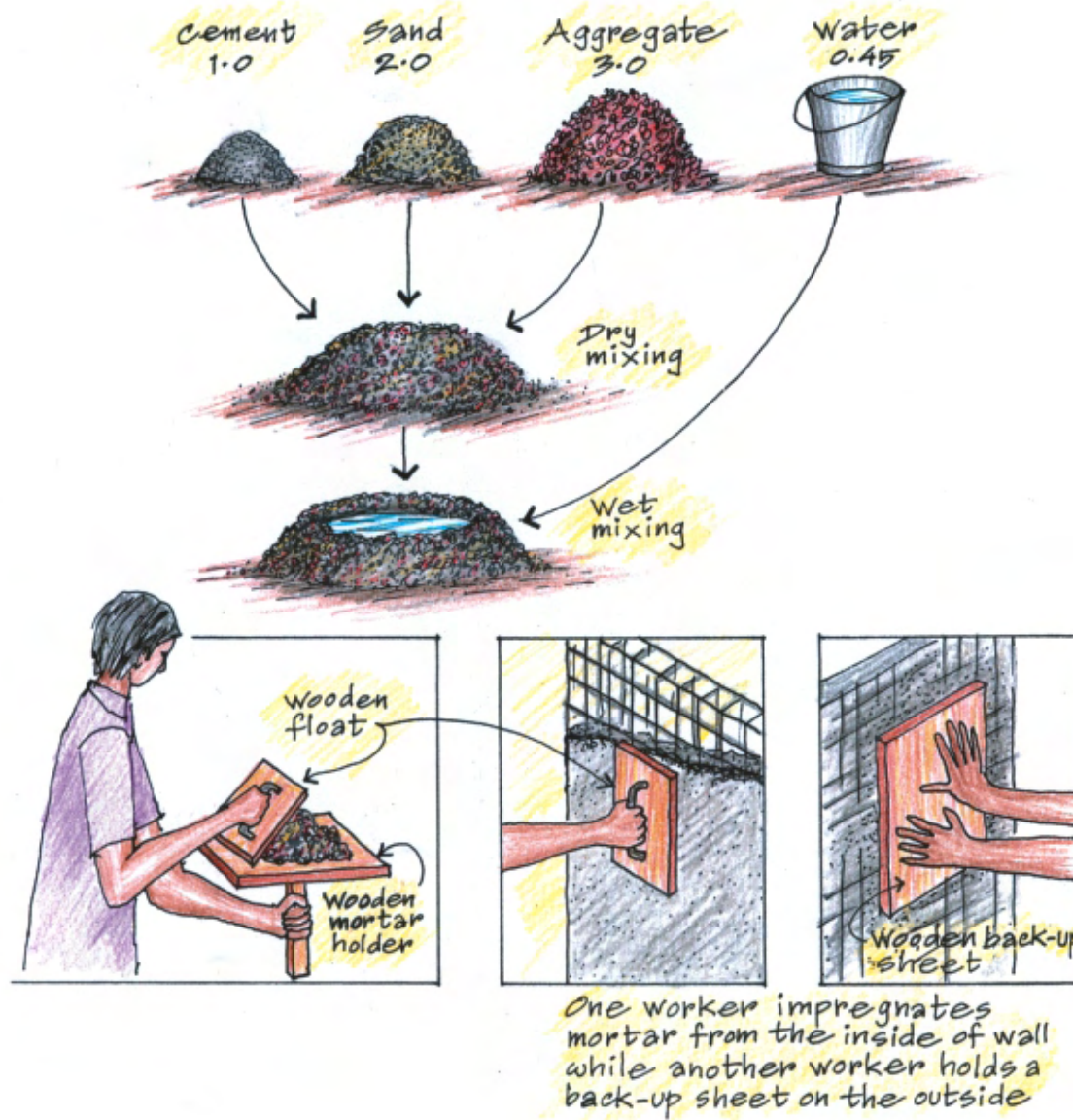

Fig. 5.6 Ferrocement construction process  
(adapted from Sharma and Gopalratnam 1980)

## 5.3 METAL SECTIONS

- ❑ MS (mild steel) or galvanized iron (GI) sections in the form of angles and pipes can be used to build the structural frame of a house. MS is usually less expensive than GI and more widely available.
- ❑ The advantages compared to untreated timber or bamboo are longer life in wet and flood-prone climate and lesser cost than good quality timber. Compared to concrete components, MS or GI sections are lighter and hence easier to transport and handle.
- ❑ The disadvantage is that it often proves difficult to construct in rural areas because of lack of available skills and tools.
- ❑ Difficult to repair or replace in remote rural areas.

### 5.3.1 Metal Post

- ❑ MS or GI post can be made with pipe of 1 ½ inch diameter with its wall thickness of ⅛ inch. Alternatively, MS or GI angle section can be used, but for adequate support and strength it should be at least 2 inch x 2 inch x ¼ inch.
- ❑ Posts can be attached with nuts and bolts to a timber or metal roof structure, or welded if the roof structure is also of metal. However, nuts and bolts are better because it allows ease of dismantling and also welding equipment is often not available in rural areas.
- ❑ A common mistake is to bury the lower end of metal posts into the ground, which leads to corrosion and weakening of the structure. Ground contact should be avoided and they should instead be supported on concrete stumps (see sections 2.2.2 and 5.1.1).
- ❑ Exposure to rain should be avoided by using metal sections on the inside surface of walls.
- ❑ MS posts should be painted with corrosion resistant paint, typically red oxide which is the least expensive.
- ❑ If they can be afforded, bracing elements should be used for wind resistance.

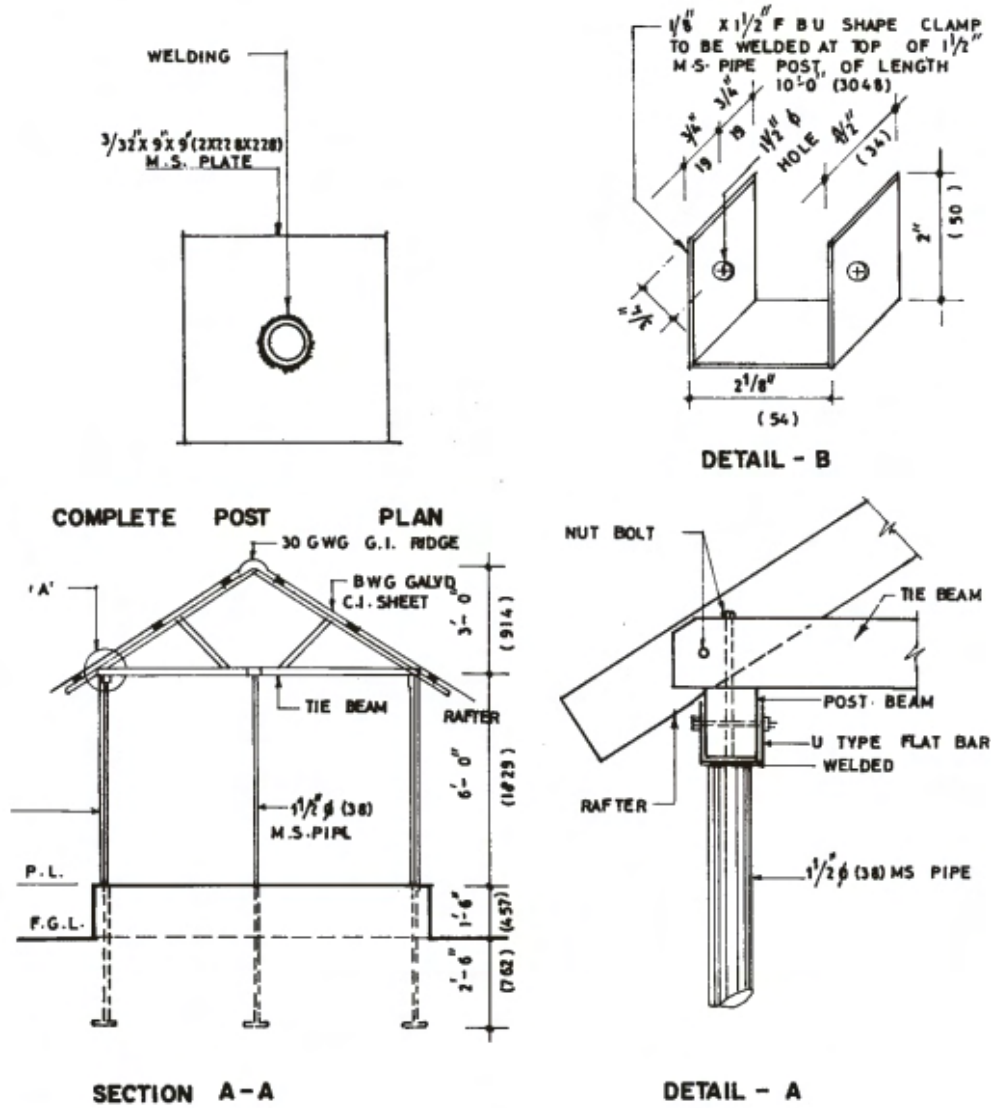

Fig. 5.7 Example of metal structural frame in house design by EDM (from EDM)

### 5.3.2 Metal Roof Structure

- MS or GI roof structure can be made typically with  $1\frac{1}{2}$  inch x  $1\frac{1}{2}$  inch x  $\frac{1}{8}$  inch section.
- It is advisable to make trusses for better strength, of which a variety of designs are possible. However, if that proves too expensive, a simpler structure of rafters, purlins and wall/post plate can be made.
- The members of the roof structure can be welded to each other, but if welding equipment is not available, they should be designed to be connected by nuts and bolts.
- MS angle roof structure should be painted with corrosion resistant paint (red oxide).

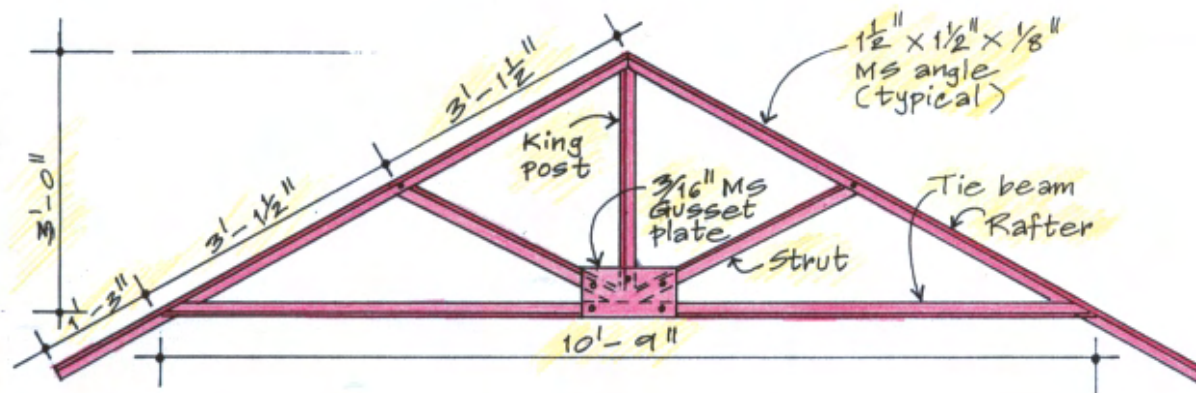

Fig. 5.8 MS angle roof truss used by Caritas (adapted from Caritas) and house with MS angle truss built by Proshika

## 5.4 TIMBER

- Completely timber houses are uncommon and timber is mostly used only as framing elements, such as roof structural frame, posts and framing for CI sheet walls. Stilted houses, which are somewhat uncommon in rural areas, often have a floor of timber planks.
- Good quality timber, such as *garjan*, although in high demand, is generally expensive and imported from hilly areas and does not grow in the floodplains. Low-income villagers can seldom afford it.
- In southern regions close to the coast, bamboo is less widely grown and timber is more in use in house construction.

### 5.4.1 Utilization Aspects

- Utilization of local timber should be promoted instead of using timber imported from other areas. For example, in southern areas timber from various types of palm trees, such as betel nut (*supari*), palmyra (*taal*) and mature coconut tend to be used, and their production should be supported.
- Rural housing programs should include a component on promotion of cultivation of trees that can be grown on the homestead. There is a wide variety, some examples include raintree (*rendikoroi*), dung (*badam*), wild mangosteen (*gab*), rosewood (*shishu*) and mast tree (*debdaru*).
- Although there are nowadays sawmills in most small towns and market places, traditional village-based timber production specialists using simple equipment such as handsaw and machete provide service to low-income villagers. Such specialists should be supported.

## 5.4.2 Timber Treatment and Protection

- Chemical treatment of large timber sections require pressure treatment with expensive and sophisticated equipment. Unless part of an extensive program, use of such treated timber would not be feasible.
- However, for smaller sections of less thickness (maximum 1½ inch), the dip diffusion method as for bamboo treatment (see sections 2.3.2 and 3.4.2.1) can be followed.
- If chemical treatment proves difficult, timber should be seasoned properly by the traditional method of completely immersing in water for at least one month.
- If timber posts are used, they should not be buried into the ground and instead should be supported on concrete stumps (see sections 2.2.2 and 5.1.1).
- Surface treatment such as painting with creosote or bitumen can serve as waterproofing.
- Exposure to rain should be avoided by using timber members on the inside surface of walls.



*Fig. 5.9 Sawmill in a small town*



*Fig. 5.10 House made of timber in Bhola, where supply of bamboo is limited*

## 5.5 STILTS

- Although raising house on stilts seems a logical solution for flood-prone areas, it is not very common, possibly due to cultural reasons.
- There are, however, examples of houses on stilts in some flood-prone regions and also urban informal settlements are sometimes built on stilts on water-logged land which is of low demand. Roadside shops are also quite often stilted and could serve as examples for introduction in houses in flood-prone areas.
- Typically such houses are raised on bamboo or timber stilts and have a floor made of split bamboo sections or timber planks.
- Because good quality timber is generally expensive and scarce in many areas, stilted housing is usually prevalent in areas that are relatively better-off economically, or where timber is available locally, especially if the floor is made of timber planks.
- The use of RC posts as stilts is becoming common in areas with a tradition of stilted housing, substituting the typical timber and bamboo stilts. These have the advantage of being water-resistant and hence more durable.
- Usually bamboo stilts have to be replaced within 2-3 years and although timber stilts can last longer depending on the type of wood used, they are still less durable than RC stilts. RC stilts cost substantially more than bamboo, but are not significantly expensive than good quality timber stilts.
- Examples of stilted houses could serve as a basis for replication in other flood-prone areas based on participatory consultation with local communities.





*Fig. 5.11 Stilted houses near Mawa*  
1. Example of a stilted house  
2. Stilted house being built  
3. Stilt construction detail showing connection between RC Post and timber members

## Chapter 6 WIDER LINKAGES

### 6.1 DESIGN AND LAYOUT OF HOMESTEADS

#### 6.1.1. Typical Layout Features

- Typically, rural homesteads follow a courtyard layout. The basic features are:
- A group of separate buildings surround an open space and thus define the courtyard.
- Each building is essentially a one-roomed structure accommodating different functions such as dwelling units for extended family members, kitchens and granaries.
- Toilets and outhouses such as cowsheds are located on the periphery of the homestead.
- The layout is introverted, that is, the buildings face away from the outside and are accessed through the courtyard. Entry into the compound from the outside is through gaps between buildings.
- The homestead is extensively planted with trees along the boundary and strengthens the introverted layout.

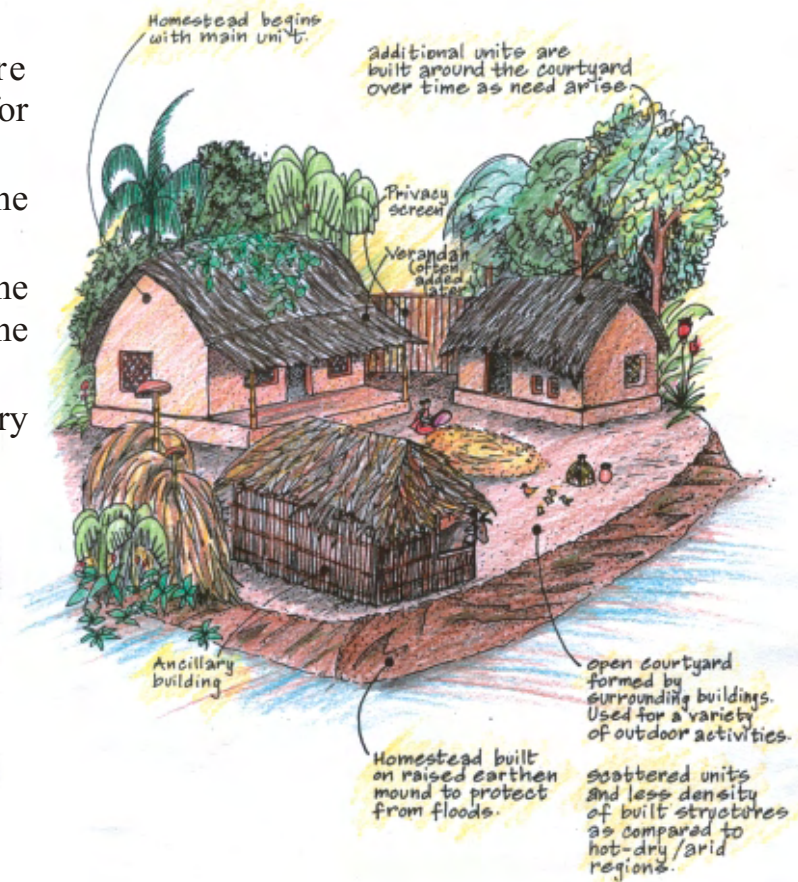

Fig. 6.1 Typical courtyard layout of rural homesteads (photo: D.M. Hassan)

### 6.1.2. Design Aspects to be Considered for Flood

- The central part of the courtyard should be its highest point, sloping gently (1% minimum slope) to the edges to allow drainage.
- Drainage channels connected to nearby water bodies should be created to prevent stagnation of water within the homestead, especially around the edges of buildings.
- A small supply of old bricks should be kept handy so that they can be used as temporary stepping stones to connect the separate buildings in the homestead in case of water-logging in the courtyard.
- Similarly, before the wet season, a small supply of bamboo poles should be stockpiled which can be used for making temporary bridges between houses and to the outside.
- In some flood-prone areas, houses have a built-in wooden/ bamboo platform (*machan*) normally used as storage space, but during flood serves as a raised refuge area. This practice should be encouraged and promoted for wider replication.
- The main entry into the compound should be raised to allow access during flood.

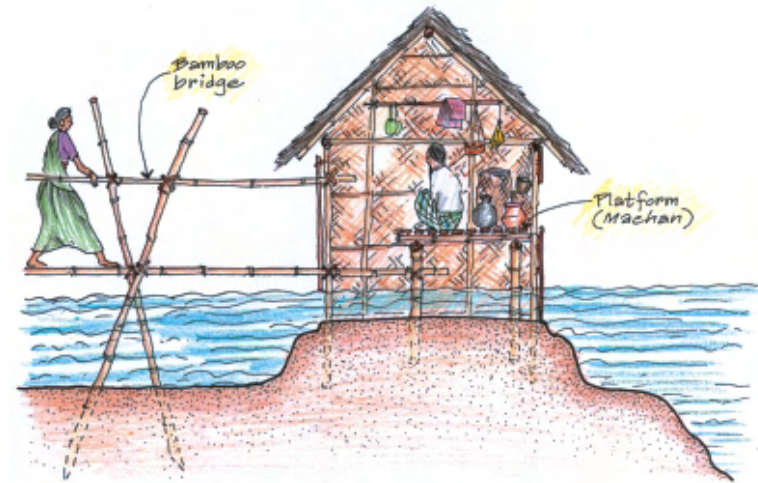

Fig. 6.2 Homestead design aspects and photo showing house in flood-prone area of Manikganj with screened off machan which is normally used for storage

## 6.2 LAND SUITABILITY

- The basic requirement for housing is land, which should ideally be suitable for building upon.
- However, in Bangladesh because of high population density and competition for land, acquiring suitable land for settlement is difficult and sometimes impossible for low-income households.
- Therefore, within the framework of organized housing programs by community development organizations, this problem should be addressed, which would contribute to the quality of efforts to build adequate flood-resistant housing.

### 6.2.1 Land Selection

*The following criteria should be considered when selecting a site for housing:*

- The land should be higher than the last recorded flood level in the area.
- It should be easily accessible and there should not be any actual or perceived barriers to access.
- Building housing on land that was previously abandoned/ polluted water body or garbage disposal site should be avoided because of danger of groundwater contamination and land settlement and consequent damage to houses, especially during flood.
- The space around the land should be open as much as possible to allow adequate air flow, ventilation and light.
- There should be a nearby ditch, canal or other appropriate place for drainage of water away from the site.
- Building on land should be avoided where there is evidence of arsenic above the permissible level (>50 ppb) within a 1600 feet radius, otherwise there is danger of groundwater supply contamination.
- In the case of selecting location of land to settle a new community, proximity to different infrastructure and employment opportunities should be considered.

## 6.2.2 Land Preparation

- Building homesteads on raised earthen mounds is a typical indigenous practice in flood-prone areas. This is a basic form of land preparation required prior to house construction.
- Earth for raising the land is often obtained by excavating a pond on the land, which is later used for rearing fish and bathing. However, if sufficient land is not there, earth has to be brought in from elsewhere, which increases the cost of land preparation. In such a situation, it should be attempted to obtain earth from a source as near as possible to reduce transport and labor costs.
- Four basic steps should be followed: 1) Leveling (achieving appropriate level); 2) Dressing (adding soil to raise level); 3) Turfing (planting soil-binding vegetation); 4) Compaction (consolidating loose soil).
- Important to remember that the soil should be thoroughly compacted to reduce subsequent settlement. Nonetheless, some settlement is to be expected, therefore the land should be raised to such an extent that even if some settlement occurs, it would still be above flood level.
- Once the land has been raised, the edges of the raised mound should be planted with trees and vegetation to bind the soil and prevent it from sliding down and also to protect it from erosion.
- The recommended slope of the edges is 1:2 for loose or sandy soil and 1:1.5 for cohesive soil.
- Shoring of the sides of the homestead mound with bamboo or timber slats should be done until vegetation growth is established.
- The land preparation process should be done during the dry winter period because it would be difficult during the wet season.
- It is usual that the land preparation process can cost up to 25% of the price of land, especially in low-lying areas. This should be taken into account before considering development of land for housing in flood-prone areas.

### 6.2.3 Legal Aspects

- Before implementing housing projects, landownership issues should be addressed. Four probable scenarios can arise, each requiring legal action accordingly:
- Beneficiary might reside on highly unstable land, such as *char* (riverine island) or erosion-prone area. Organization should seek possibility for resettlement or land protection program.
- Beneficiary might reside on *khaas* (government-owned) land. Organization should negotiate for permission from local Assistant Commissioner for land for at least 15-20 years tenure without fear of eviction. Written agreement, not only verbal, should be obtained. Possibility of acquiring the land and transferring it to beneficiary should be investigated.
- Beneficiary might reside on private land. Organization should negotiate with landowner for permission to reside and right of use for at least 15-20 years without possibility of eviction. Written agreement, not only verbal, should be obtained. Possibility of acquiring the land and transferring it to beneficiary should be investigated.
- Beneficiary might reside on own land. Organization should verify landownership documents and check against any possible dual claimant or disputes.
- Where possible, community-based groups should be mobilized to negotiate and ensure land use rights, and to serve as peer-group collateral.

## 6.3 HOMESTEAD RAISING

- In flood-prone areas, an indigenous practice is to build homesteads on a raised mound, built with earth from the excavation of canals and ponds.
- Presently, because of resource constraints, it is not always possible for people to raise homesteads adequately above flood level.

### 6.3.1 Organized Homestead Raising

- Organizations can assist by building upon the indigenous practice of homestead raising.
- Communities and households should be mobilized firstly to clarify a common flooding problem.
- Community-based groups should be formed to collect earth from local silted riverbanks or alluvial deposits, or nearby canals or ditches.
- This earth can then be used to raise existing homesteads or to build new raised homesteads above flood level.
- It is important that the piled earth is compacted properly, again using community based efforts, and with locally available hand tampers and rammers.
- When raising existing homesteads, existing houses would have to dismantled and re-erected.
- Mature trees can remain in place, but young trees may have to be re-planted.

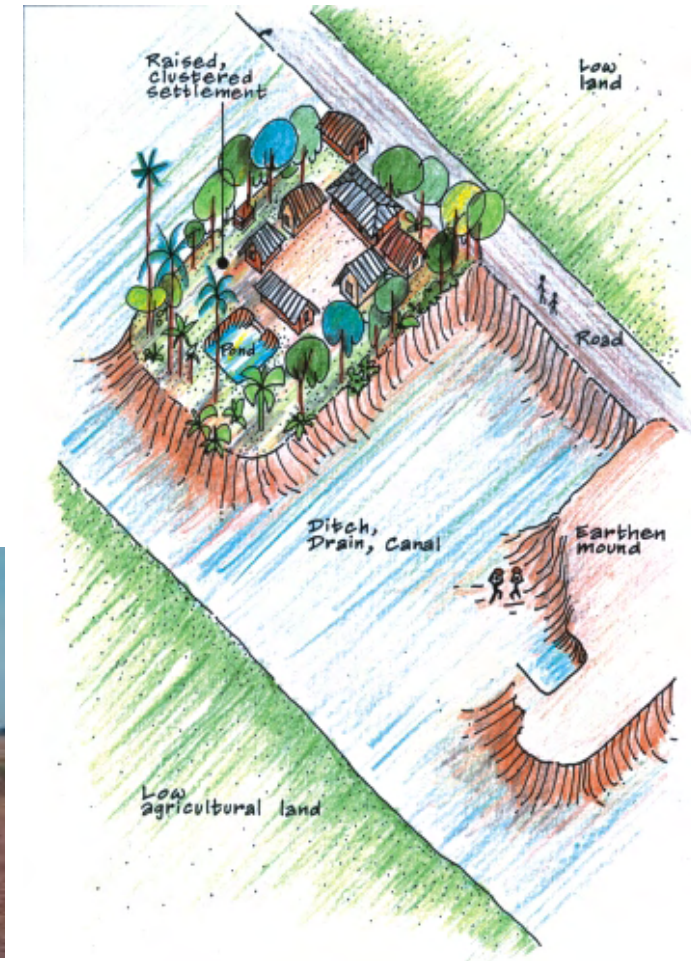

Fig. 6.3 Traditional pattern of building homestead on raised mound

## 6.4 LANDSCAPING

- ❑ Planting design and selection of trees is the main aspect of landscaping discussed in this section. Land selection, preparation and homestead raising are also part of landscaping in the broader sense, but they are discussed separately to highlight their importance.

### 6.4.1 Objectives

- ❑ Planting should be done in a rural homestead primarily to meet the following objectives:
- ❑ To protect the raised earthen homestead from erosion and flood impact.
- ❑ To get food supply for family members and for income generation.
- ❑ To produce timber supply for house construction and repair.
- ❑ To reinforce the introverted courtyard layout and thereby ensure privacy and define territory.



*Fig. 6.4 Homestead raised through community-based program of CARE in Kurigram*



*Fig. 6.5 A rural homestead with traditional landscaping in flood-prone area of Manikganj (photo: Kh. Hasibul Kabir)*



## 6.4.1 Planting Criteria

- Trees should be planted in such a way that the courtyard can get adequate sunlight.
- Native plants of the floodplains should be given priority as they are part of the local ecosystem.
- Trees which provide fruit as well as timber should be given more importance. These also act as financial security.
- Trees with deep and dense root system (coconut, date palm, etc) should be used on the slope of the homestead mound. Trees which can grow by the water and can withstand floodwater for a long time (*hizal, gab, borun, pitali*, etc) should be planted in the lower part of the slope.
- Grasses with affinity for wetness and other ground-cover herbaceous plants (also a source of vegetables) should be planted on the slope as soon as the land is prepared so that heavy rain cannot hit the soil directly.
- Planting catkin grass on the edges of the mound should be encouraged because it protects from erosion and is also a source of fuel, fodder and building material.
- Bamboo plantation is highly recommended for every homestead as it protects the soil from erosion, can withstand both drought and flood and is an important building material source (see section 6.5).
- There should be adequate sunny area for kitchen garden to cultivate seasonal vegetables. This should be on high ground as most traditional vegetables cannot survive in floodwater.
- Some flowering trees prevalent in the floodplains (*sonalu, jarul*, etc), and water plants (*shapla, kalmi*, etc) can be recommended primarily for aesthetic reasons, but they also provide timber and vegetables.

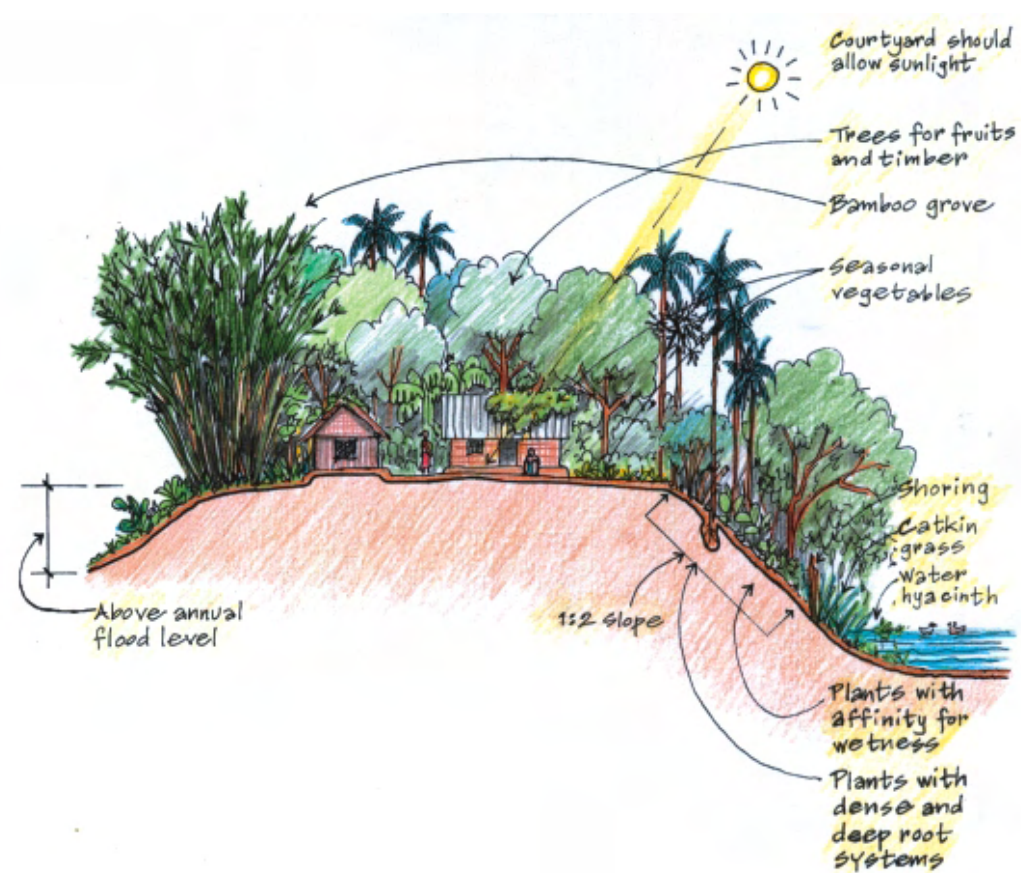

Fig. 6.6 Landscaping criteria for homestead in flood-prone area

## 6.5 CULTIVATION OF NATURAL BUILDING RESOURCES

Some of the main natural building resources are timber and bamboo. In sections 5.4 and 6.4, issues relating to appropriate landscaping, tree cultivation and production of timber for use in house construction is discussed. Therefore, in this section aspects of bamboo cultivation is discussed.

### 6.5.1 Bamboo Supply

- Although being a vital resource for house construction, bamboo has become scarce in many areas with a resulting increase in price. Inadequate disease prevention and mismanagement of existing resources contribute further to decline in stock.
- There is thus the need for regeneration of bamboo supply through improved cultivation and management. There are many afforestation and social forestry programs in Bangladesh, but none particularly address bamboo cultivation.
- There is also potential for introducing hazard-free bamboo treatment (see sections 2.3.2 and 3.4) as a sustainable process for the utilisation and consumption of the resource within the framework of a wider initiative for its improved and sustainable regeneration, production and management.
- Various livelihoods are linked to bamboo and an initiative for bamboo regeneration would also regenerate these livelihoods.

## 6.5.2 Bamboo Farming

- Bamboo farms should be established to demonstrate the potential of improved and sustainable bamboo production and to address the environmental implications of the decline of this local resource.
- Improved bamboo propagation and cultivation methods have been developed by the Bangladesh Forest Research Institute (BFRI) and bamboo farms would allow extending these methods.
- Other than improved bamboo farming, some of the main activities of the farm should be:
  - ▲ Further research and development of bamboo cultivation and propagation methods.
  - ▲ Bamboo treatment with adequate safety measures.
  - ▲ Production and marketing of treated bamboo building products, furniture, household and agricultural implements and handicrafts.
- Such farms founded on the principle of sustainable production of bamboo would allow generating sustainable livelihoods for local cultivators, artisans, manufacturers and entrepreneurs.
- The farm can work as a model of how bamboo cultivation can be part of the rural environment and serve a variety of domestic and community needs of a village.
- It can also work as an educational center for documentation, research, exhibition and dissemination.

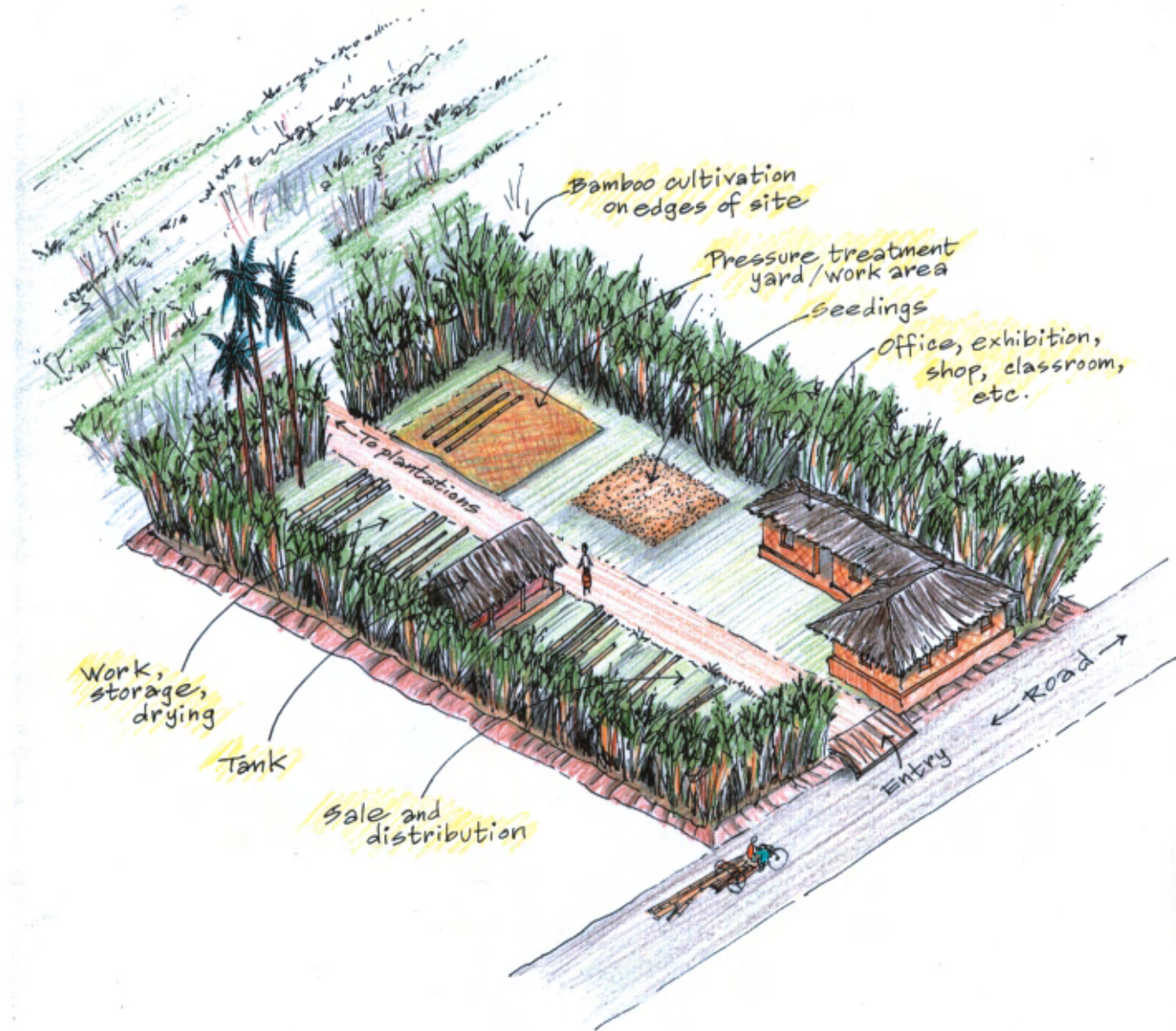

Fig. 6.7 A model bamboo farm (adapted from Dunham 1991 and Farrelly 1996)

## 6.6 BASIC INFRASTRUCTURE

Because of the general absence of centralized infrastructure provision in rural areas, housing programs have to consider provision of basic services at the individual homestead or community level.

### 6.6.1 Water Supply

- Shallow tubewell is the most cost-effective and convenient form of water supply at the homestead level, especially in areas without arsenic contamination of groundwater, such as in most *chars* (riverine islands).
- In areas suffering from arsenic contamination, deep tubewell can be used, but since it is comparatively expensive, cost considerations have to be taken into account, perhaps through community ownership.
- In flood-prone areas, tubewell should be located on raised ground, or itself should be raised by extending the riser column, to avoid contamination by floodwater and also to continue serving during flood.
- Collecting rainwater for household uses can be a suitable option, especially in areas with arsenic contamination or coastal areas with salinity in groundwater, a method discussed in section 2.4.3. Adequate storage for long-term use and treatment against micro-organisms are some of the challenges that have to be considered.
- Dug well is a traditional water supply option for arsenic-free areas. However, to avoid contamination from above, it should be covered. In flood-prone areas, the side walls of the well should be high enough to prevent flow of water inside during flood.
- Various types of traditional and innovative filters are available for treatment of surface water and removal of arsenic, which can be utilized based upon local availability and water source.

## 6.6.2 Sanitation

- The most basic and important aspect towards ensuring hygienic sanitation is to discourage and prevent open defecation and use of hanging latrines. These practices contaminate water sources and is a major cause of spreading diseases during flood.
- Simple pit latrine is the most cost-effective and somewhat hygienic sanitation option. An improved version with a concrete squatting slab is now available in most places and should be recommended.
- A further improvement is the ventilated pit latrine which removes foul odor and if the vent is fitted with a fly screen, it also prevents insect infestation.
- The community-based “100% Sanitation Approach” pioneered by VERC (Village Education Resource Center) focuses on hygiene education for behavioral change and technological support for a variety of latrine options. This can be referred to for replication.
- As with water supply point in flood-prone areas, the latrine should be located on raised ground or itself should be raised by having high lining walls built with concrete rings. The basement slab can also be raised and steps provided for ease of access.

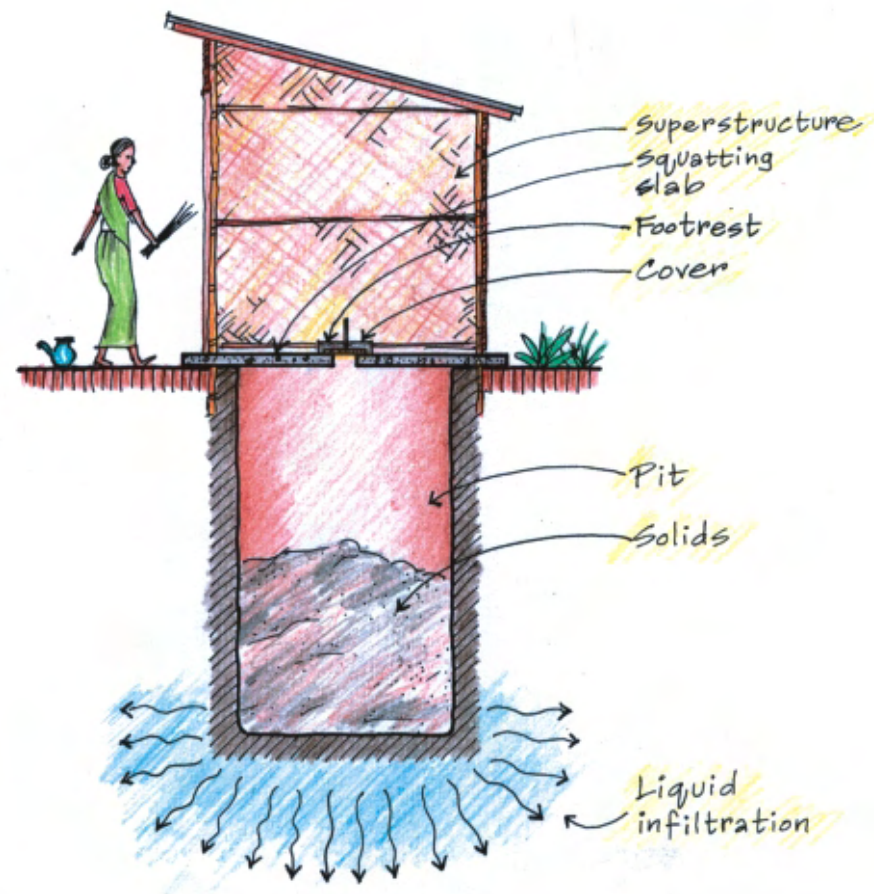

Fig. 6.8 Improved simple pit latrine  
(adapted from ITN 2003)

### 6.6.3 Energy

- Because of the lack of widespread coverage of centralized energy services and because of the financial and environmental costs of fossil and organic fuel, renewable energy should be considered for rural housing.
- At the moment, harnessing solar energy using photovoltaic (PV) solar panels for electricity generation is the most applicable option among other renewable energy technologies for utilization at the individual homestead level.
- Important positive outputs of electricity supply are increased scope for children's evening education and indoor income-generation.
- Current prices of solar energy systems are prohibitive for very poor households, but affordable for slightly better-off households. Organizations should promote and motivate households that can afford it to invest in solar energy systems.
- Organizations such as the Grameen Bank and BRAC are providing solar energy systems as part of microcredit programs. Other organizations should follow this example and build upon existing experience to develop flexible and soft financing schemes.
- Solar energy systems are advantageous in flood-prone areas because the panels are raised on a pole or on the rooftop and thus avoid damage by floodwater.



*Fig. 6.9 Grameen solar system*

## 6.7 FINANCING

Financing for housing is generally within the framework of donor-driven programs which provide building materials or houses, usually to disaster-affected communities. Such a process is obviously limited by resource constraints in a context where the need for improved housing is extensive and widespread, and in most cases, economically unsustainable. Housing microcredit can be a possible solution for wider outreach, discussed below.

### 6.7.1 Housing Microcredit

- Rural households face serious financial constraints in building adequate housing. They have severely limited access to financing for housing and seldom obtain institutional support for housing except in post-disaster circumstances.
- Microcredit programs are widespread throughout Bangladesh, but very few provide financing specifically for housing.
- Some of the few existing rural housing finance programs provide loans that are too large for low-income people to repay, especially that there is no direct financial return from housing. There are examples of widespread default.
- In many parts of Bangladesh, low-income households build a house of natural building materials within Tk 2000-3000. The loan from credit programs is at least Tk 10,000 or more, an unaffordable option for many. These programs tend to benefit somewhat better-off people.
- In this context, housing is an incremental process where a house is built and then repaired, extended and made more durable over a long period of time. It is not a ‘one-off’ durable product built at a time.
- It can therefore be envisaged that if households could access such small amounts of funds on an institutional basis, they would be able to incrementally upgrade their houses within their level of affordability.
- In many cases, when a household is unable to carry out adequate repair during one building season, it becomes vulnerable to natural hazards and climatic stress. A ‘small loans’ program might prove valuable in such a context by providing a degree of security, as well as the possibility of gradually owning a more durable house.
- In this process, small improvements can be introduced at each increment and over the long term this can result in a durable and safe house. *Ideas for technological improvement discussed in this handbook can find their place within this framework.*
- Such a program should be tested first for its utility and potential for application by organizations which have an existing community development network, ensuring effective management and monitoring of credit performance. The results can indicate directions for appropriate low-income housing microcredit programs.



## 6.7.2 Implementing a ‘Small Loans’ Program

- ❑ In order to understand the potential of an incremental housing microfinance approach, it needs to be tested as a pilot-program. This can be carried out within existing community development programs for effective management and monitoring, integrated with other program activities.
- ❑ At this pilot stage, 40-50 households should be supported by the program. Their credit performance should be monitored and evaluated over a period of 3-5 years, with an intensive interim evaluation.
- ❑ The results of the pilot-program would indicate possibility for extension and continuity, and the feasibility of developing a long-term full-fledged program that can be replicated.

## 6.7.3 Implementation Stages

- ❑ **Stage 1** – Pilot program should be formulated including schedule, resources, team, staff training, logistics.
- ❑ **Stage 2** – Pilot-program should be implemented in selected area with monitoring by implementing agency. Implementation should coincide with the main construction season in the dry winter period when households require funds for house construction and repair.
- ❑ **Stage 3** – Interim evaluation, preferably independent, should be conducted. This should be timed after the rainy season to assess the critical challenges to housing structures at this time of year. Report should be reviewed as widely as possible.
- ❑ **Stage 4** – Incremental loan strategy should be implemented over another phase. This should again coincide with the construction season. Documentation to be made of changes to houses and progress should be monitored. Credit performance should be monitored.
- ❑ **Stage 5** – Independent evaluation should be conducted and report submitted for review. Consultations with stakeholders should be held on potential for extension and continuity. Dissemination and replication methods should then be planned.

## 6.8 LIVELIHOOD OPTIONS

- ❑ The construction sector is an important livelihood source and organizations should support this sector with the view of introducing appropriate flood-resistant products within income-generating schemes.
- ❑ As part of market development and making more products available to rural communities, development of small-scale building materials suppliers or building component producers should be supported.
- ❑ New technologies, such as compressed earth blocks and bamboo treatment, can be introduced and supported by organizations by promoting them to local small-scale building materials suppliers and producers.
- ❑ Microcredit programs should be developed specifically to target small-scale building materials suppliers and producers.
- ❑ To identify possible entrepreneurship opportunities, market surveys should be carried out to determine the costs and sources of building materials used in flood-prone areas.
- ❑ In many places, such as flood-prone *chars* (riverine islands), there are only a few fixed markets (*haat*) that operate regularly (once or twice weekly). Therefore additional market places need to be developed as a way of increasing the range of building products available and also to reduce their cost.
- ❑ Organizations, especially governmental ones, can encourage development of markets by providing facilities such as areas raised above flood level so that markets can operate throughout the year. Planning and location of new markets to minimize flood risk can contribute towards livelihoods development.

## SELECTED REFERENCES

- AHMED, K.I. (1994) *Up to the Waist in Mud: Earth-Based Architecture in Rural Bangladesh*. Dhaka, University Press Ltd.
- BARKER, A. (1994) *Bangladesh*. Oxford, UK, Heinemann Library.
- BERGLUND, M. (1986) *Stone, Log and Earth Houses*. Watertown, USA, Tauton Press Inc.
- CARITAS (undated) *Caritas Model House*. Project document. Dhaka, Caritas.
- CHISHOLM, M.P. (1979) *A Study of the Provision of Rural Housing in Bangladesh*. BArch thesis. Newcastle, UK, University of Newcastle.
- DEVELOPMENT ALTERNATIVES (undated) *Building with Compressed Earth Blocks*. New Delhi, India, Development Alternatives.
- DUNHAM, Daniel C. (1991) *“Upgraded Bamboo as a Housing Material”*. Unpublished paper. New York, City University of New York.
- EDM (Enfants du Monde) (undated) *Shelter for Shelterless Families*. Dhaka, EDM.
- FARRELLY, D. (1996) *The Book of Bamboo*. London, Thames and Hudson.
- ITN (International Training Network) (2003) *Sanitation Strategies and Technologies: Flood-Prone and High Water Table Areas of Bangladesh*. Dhaka, ITN-BUET.
- JANSSEN, J.J.A. (1995) *Building with Bamboo: A Handbook*. London, Intermediate Technology Publications Ltd.
- MAYO, A. (1988) *Cyclone-Resistant Houses for Developing Countries*. Watford, UK, Building Research Establishment (BRE).
- NMBA (National Mission on Bamboo Applications) (2004) *Building with Bamboo: Training Manual*. New Delhi, India, NMBA.
- NORTON, J. (1986) *Building with Earth: A Handbook*. London, Intermediate Technology Publications.
- SERAJ, S.M. and AHMED, K.I. (2004) *Building Safer Houses in Rural Bangladesh*. Dhaka, BUET.
- SHARMA, P.C. and GOPALARATNAM, V.S. (1980) *Ferrocement Water Tank*. Bangkok, Thailand, IFIC.



A large proportion of the countryside in Bangladesh is flood-prone, which primarily affects the predominantly low-income population. There is a need for developing housing which is appropriate for flood-prone areas, where the suggested solutions are 'cost-effective' - that is, rationalization of economy without compromising quality. There are various books and publications on this subject, but what is required is a simplified, illustrated handbook such as this, which distills essential aspects of the subject with a view towards ease of dissemination and application. The aim is to provide practical and useful guidelines which can be used by organizations active in this field to design and construct such housing that can reduce the risk of communities living in flood-prone areas.

*K. Iftekhar Ahmed (PhD, Oxford Brookes University, UK; MArchS, MIT, USA; BArch, IIT, India) is Associate Professor in Architecture at Bangladesh University of Engineering & Technology (BUET), Dhaka and visiting faculty at BRAC University, Dhaka. He has extensive academic and professional experience in the field of rural housing and has written several books on the subject. He is currently working as Shelter Specialist at the United Nations Development Programme (UNDP), Dhaka on leave from BUET.*

**ISBN: 984-32-2163-X**

## Safer communities and sustainable development through disaster reduction



Asian Disaster Preparedness Center

P.O. Box 4, Khlong Luang, Pathumthani 12120, Thailand

Tel: (662) 5165900-10

Fax: (662) 5245350, 5245360

email: [adpc@adpc.net](mailto:adpc@adpc.net)

website: [www.adpc.net](http://www.adpc.net)