



**Cuba Transition  
Project**

**REHABILITATING EDUCATION  
IN CUBA:  
ASSESSMENT OF CONDITIONS AND  
POLICY RECOMMENDATIONS**

**By**

**Graciella Cruz-Taura**

INSTITUTE FOR CUBAN AND CUBAN-AMERICAN STUDIES  
UNIVERSITY OF MIAMI





**REHABILITATING EDUCATION  
IN CUBA:  
ASSESSMENT OF CONDITIONS AND  
POLICY RECOMMENDATIONS**

# Cuba Transition Project – CTP

The Cuba Transition Project, at the Institute for Cuban and Cuban-American Studies (ICCAS), University of Miami, is an important and timely project to study and make recommendations for the reconstruction of Cuba once the post-Castro transition begins in earnest. The transitions in Central and Eastern Europe, Nicaragua, and Spain are being analyzed and lessons drawn for the future of Cuba. The project began in January 2002 and is funded by a grant from the U.S. Agency for International Development.

## Programs and Activities

- The CTP is publishing original research, with practical alternative recommendations on various specific aspects of the transition process, commissioned and written for the CTP by ICCAS Staff and U.S. and foreign scholars with expertise on Cuba.
- The CTP is developing four key databases:
  1. A full-text database of published and unpublished articles written on topics of transition in Cuba, as well as articles on transition in Central and Eastern Europe, Nicaragua, and Spain. It also includes an extensive bibliography of published and unpublished books, theses, and dissertations on the topic.
  2. A full-text database of Cuba's principal laws, in Spanish, its legal system, including the current Cuban Constitution (in English and Spanish), and other legislation relating to the structure of the existing government. Also included are the full-text of law review articles on a variety of topics
  3. A database on joint ventures and foreign investments in Cuba.
  4. Cuba On-Line, a database of historical and current information on Cuba. It includes a chronology from 1492 to the present and a comprehensive bibliography on most Cuba related topics.
- The CTP publishes electronically an information service, *Cuba Focus*, reporting on current issues of importance on Cuba.

All the products of the CTP, including the databases and subscription to *Cuba Focus*, are free and available to the public on the web at <http://ctp.iccas.miami.edu>.

The CTP can also be contacted at P.O. Box 248174, Coral Gables, Florida 33124-3010, Tel: 305-284-CUBA (2822), Fax: 305-284-4875, and e-mail: [ctp.iccas@miami.edu](mailto:ctp.iccas@miami.edu).

**REHABILITATING EDUCATION  
IN CUBA:  
ASSESSMENT OF CONDITIONS AND  
POLICY RECOMMENDATIONS**

Prepared for the Cuba Transition Project (CTP)  
Institute for Cuban and Cuban-American Studies  
University of Miami

**By**  
**Graciella Cruz-Taura**

*This publication was made possible through support provided by the Bureau for Latin America and the Caribbean, U.S. Agency for International Development, under the terms of Award No. EDG-A-00-02-00007-00. The opinions expressed herein are those of the author and do not necessarily reflect the views of the U.S. Agency for International Development.*

# Contents

<i>Acknowledgments</i> .....	ii
<i>Executive Summary</i> .....	iv
Introduction .....	1
Methodology .....	2
The Cuban Educational System after 1959 .....	3
Education in the 1990s .....	7
Current State of Education in Cuba .....	10
News Analysis of the Cuban Press .....	11
Challenges from Within .....	15
Diagnosis .....	27
Policy Recommendations .....	29
<i>Notes</i> .....	38
<i>Bibliography</i> .....	44
<i>Appendices</i> .....	55
<i>About the Author</i> .....	85

## Acknowledgments

The scope of this study would be narrower had I not spent hours on the telephone discussing education with members of the **Colegio de Pedagogos Independientes de Cuba**, the independent organization that groups dissident school teachers in Cuba. They speak out openly and defiantly, at their own risk, on behalf of Cuban school children. While I was on the line interviewing Roberto Larramendi, the Colegio's vice-president, he was arrested by Cuban State Security on 13 March 2002. The echo of his wife's cry for help still resonates in my ears. One year later, other similar echoes continue to be heard. Roberto de Miranda, the Colegio's president, was among the seventy-five dissidents arrested during the Cuban government's crackdown in March 2003. He was condemned to twenty years in jail during a summary trial for

the illegal and counterrevolutionary College of Independent Teachers of Cuba, of which he named himself head. He also dedicated himself to intentionally and maliciously criticizing the objectives of the Cuban education system, and tried to minimize the achievements in this area of our revolutionary process.<sup>1</sup>

Miranda has been designated a "prisoner of conscience" by Amnesty International.

As usual, the librarians of the University of Miami Cuban Heritage Collection provided invaluable support; Lesbia Orta Varona went beyond the call of duty to provide me with all of the materials. Guillermina Carrandi Gorrita and Orlando Gutiérrez Boronat introduced me to sources in Venezuela and Cuba. The patience and professional skills of Georgina O. Lindskoog were instrumental in my completion of this monograph.

Antonio Jorge's erudite observations helped me tie educational reform to cultural and moral imperatives specific to Cuba. I also thank all those who offered helpful comments on an earlier version of this study, which I presented at the Twelfth Annual Meeting of the Association for the Study of the Cuban Economy.

I am grateful to those colleagues at the Department of History of Florida Atlantic University who facilitated my research for this study. During Spring 2002, Chairperson Sandy Norman authorized release time

and Ben Lowe traveled twice a week to the FAU northern campus to teach classes so that, in turn, Alex Brown could teach a Latin American history course in Boca Raton, at the main campus where I am based.

Finally, I acknowledge the trust and advice received from Jaime Suchlicki, Director of the University of Miami's Institute for Cuban and Cuban American Studies and Principal Investigator of USAID's Cuba Transition Project, with whom I have been fortunate to argue Cuba issues for over thirty years.



## **Executive Summary**

One decade after the collapse of the Soviet world, the Cuban educational system is besieged by diminishing resources, ideological ambiguity, and labor demands unable to accommodate the scientifically trained graduates the Revolution had showcased as one of its major accomplishments and as the cornerstone of its legitimacy. It was a system designed to service Marxist-Leninist ideology and the one-party state. It fails in the general quality of instruction and in cost-effectiveness, issues related to its centralized ideology-driven structure. The Cuban system suffers from poor management leadership, originating in political profiling, and from an extensive bureaucracy that contributes to its inefficiency.

If Cuba is going to make a peaceful transition into an age of globalization and post-communism, the Revolution's philosophy of education must be transformed into one that will legitimately and effectively service the individual. Fortunately, in spite of political and economic limitations, Cuba possesses the human resources to rehabilitate its educational system from within. With a restoration of civil liberties and the financial support of the international community, Cuban teachers can proceed to implement a new educational system.

The following report (1) describes the structure of Cuba's educational system as developed after the Revolution of 1959; (2) assesses the state of said system after 44 years; and (3) makes recommendations for a transition project to liberate school curricula of ideological content and constraints, in line with the aspirations of any open and democratic society in the Western tradition while taking into account the history of Cuban education and national goals as well as the experience of Central and Eastern European nations.

## **Summary of Recommendations**

### *General*

- Maintain free and universal access to education through the ninth grade.
- Enforce equal opportunity by servicing those students with the qualifications to proceed to the secondary and tertiary levels

regardless of race, gender, religion, or ideological profile.

- Improve the quality of instruction by reversing the current dependence on untrained substitutes, *maestros emergentes*, and student teachers.
- Legalize private and church-affiliated schools.

### *Curricular*

- Free contents of Marxist ideology and propaganda, particularly when the subjects are Cuban history and culture. Cuba has many qualified teachers who can be entrusted with textbook innovation. While many have only received formal training in Marxist methodologies, with adequate exposure to other perspectives and teaching philosophies, Cuban educators can prepare the basic texts for Cuban students to relate and grow intellectually.
- Integrate Civic Education into the regular curricula at all grade levels. Contents should promote respect for the rights of others, tolerance, knowledge of civil liberties, and democratic principles. The writings of José Martí can be useful in this effort although they, too, must be restored to their original context.
- Promote computer education and distance-learning programs.
- Develop teacher training programs to implement all of the above. Begin the training program with courses for small groups of the best qualified Cuban teachers who can proceed to train the docent population.

### *Administrative*

- Reduce bureaucracy.
- Enforce professional standards.
- End political profiling of students and faculty.

### *Community*

- Promote parental involvement in child education as a goal of an open society. Much needed is the restoration of parental authority over the type of education parents want for their children—public or private, religious or secular, boarding or at home.
- Provide psychological support through school seminars and meetings to discuss issues related to the transition from the pater-

nalism of a totalitarian system to facing the risks of decision-making in an open society.

- Continue the school lunch programs, a popular measure which promises better child nutrition and reduces student absenteeism.
- Secure support of independent libraries and NGOs to reduce the government's total control of educational affairs and improve the quality of services.
- Sponsor a mass media campaign to promote the value of an educated citizenry and educational opportunities for both school age and adult populations to satisfy the career and employment needs of the developing Cuban economy.

### *Executive*

- Include education as an integral element of all National Reconstruction projects to secure that funds be earmarked for training.
- Appoint an independent Board of Regent to review the adequacy, tempo, efficiency, and effectiveness of all educational reforms undertaken. The Board's membership should be limited in size but varied. Business and industry need to be represented as well as education specialists from different levels and areas of concern.

# **Rehabilitating Education in Cuba: Assessment of Conditions and Policy Recommendations**

## **Introduction**

Most assessments of the state of Cuban education continue to conclude that Cuba is an indebted, poor country with a highly educated population that is particularly well trained in the exact and military sciences. One decade after the collapse of the Soviet world, the socialist order has changed during this “Special Period in a Time of Peace,” as the Cuban government characterizes the current phase it entered after 1991. The Cuban educational system is besieged by diminishing resources, ideological ambiguity in the face of the dollar-attracting tourist economy, and labor demands and salaries unable to accommodate the scientifically trained graduates it had showcased to the international community as one of the Revolution’s major accomplishments and as a pillar of its legitimacy.

The demands of the new global economy on expertise and labor, as well as the risks and opportunities facing the individual in an open society, require an educational system ready to provide Cubans of all ages with competitive intellectual tools and technical know-how. This study considers the current state of the Cuban educational system and makes recommendations for a necessary rehabilitation of Cuban schools.

The case of Cuba after 1959 demonstrates how universal access to education was possible when government resources were devoted to the endeavor and the population was mobilized. While the totalitarian nature of the Revolution of 1959 soon structured the educational system to service its ideological and social needs; such a closed system functioned as long as Cuba operated in the isolated Communist world and economy. The inability to translate access to education into access for individual well-being haunts a government always in search of time. The Cuban experience indicates that literacy for all and higher education for many, the formula idealized by developing nations as the panacea to their ills, is not a guarantee for social and economic development in the absence of other conditions.

Throughout its forty-four year history, the Cuban revolutionary lead-

ership has occasionally recognized its failure to produce a new man in a self-sustaining economy. In spite of Cuban President Fidel Castro's own angry comments in some speeches, the regime has chosen not to change strategy. Change would have meant losing control. The nature of the socialist system clouded blemishes, including weaknesses in the Cuban educational system, by manipulating demonstrated statistics. The system seemed to offer professional advancement to any Cuban who did not question its order, especially in the presence of a generous education budget. Simultaneously, it limited the career pursuit of individuals who did not conform to its ideology. As the conditions that facilitated educational accomplishments erode, the frailties of the revolutionary experiment in education are magnified. Civil society and economic forces are trying to tear down totalitarian walls. Cuba must rehabilitate its educational system in order to maintain universal access to free education and provide career development opportunities to an informed citizenry.

The following report: (1) describes the structure of Cuba's educational system as developed after the revolution of 1959; (2) assesses the state of that system after 44 years and the changes it has begun to experience as it enters a post-totalitarian era and joins the global economy; and (3) makes recommendations to free school curricula of ideological content and constraints, in line with the aspirations of any open and democratic society in the Western tradition that values an educated and engaged citizenry. The report takes into account the history of Cuban education and national goals as well as the experience of Eastern European nations that are committed to freeing their educational systems of Marxist-Leninist ideology.

## **Methodology**

### *Phase 1 - Traditional Primary Literature*

I began research for this topic by reviewing the history of education in Cuba since colonial times so that I could better understand the impact of the Revolution of 1959 on education. I then proceeded to examine policy formulation and revisions since 1959, devoting much attention to the problems that have surfaced during the last decade. The only figures available for consideration in this paper are those provided by the Cuban

government and the United Nations; the latter depends on data provided by Cuban agencies.

### *Phase 2 - Secondary Literature*

After reviewing the relevant secondary literature, polarized as most studies of revolutionary Cuba are, I found little guidance in my effort to recommend change or continuity in Cuban educational policy. The literature published by official Cuban editorial houses, as well as most of that written by visiting scholars to whom the Cuban government provides access to academic facilities, rarely questions policy or recommends change, in uncritical acceptance of the revolutionary claim of “equity across society.”<sup>2</sup>

### *Phase 3 - Testimonial (or Nontraditional Primary) Literature*

The absence of a body of critical literature caused me to seek contact with educators in Cuba whose writings do not appear in official publications. Their testimonies and thoughts on the subject have contributed significantly to my assessment, perhaps because they are rooted in a reality that the literature on Soviet bloc education now confirms.

### *Phase 4 - Analysis*

As I have proceeded to analyze my research and consider policy recommendations, I have also benefited from the literature on international education reform that stems from academia and international organizations. I have also made use of the guidelines provided by the World Bank to diagnose the state of education in developing nations.

## **The Cuban Educational System After 1959**

The Revolution of 1959 sought to mobilize the Cuban population by using education to promote its embrace of Marxist-Leninist ideology. The Literacy Campaign of 1961 marked the first mass mobilization that would subsequently characterize the regime.<sup>3</sup> Soon, campaigns of volunteers went to the Cuban countryside to teach curricula modified at all levels to promote socialist objectives. The regime soon began opening **Escuelas de Instrucción Revolucionaria** (Schools for Revolutionary

Instruction) and sending students to Communist countries to study Marxism-Leninism and its corresponding pedagogy. The government claimed to have graduated 100,000 students from the Escuelas de Instrucción Revolucionaria by the end of 1961.<sup>4</sup> Finally, Che Guevara’s article “Man and Socialism in Cuba” provided the guiding principle of educational policy’s quest to create *el hombre nuevo* (the new man) after 1965.<sup>5</sup>

The Cuban educational experiment soon exhibited features that would continue to characterize it for the next four decades, although qualitative revisions would take place during the 1970s. Based on the literature reviewed for this report, the following are the general features that both apologists and critics attribute to the Cuban educational system:

<b>Major Features of Cuban Educational System</b>
Universal access
Seeks to engender the new socialist man; based on Marxism-Leninism
Requires a work-study component
Promotes economic development; scientifically/technologically geared
Centralizes decision making
Channels community relations through official mass organizations
Rewards and deprivations determined by political profile

Chart 1. Major features of the Cuban educational system

By 1970, Cuban schooling had reached every child in the island nation, an accomplishment that would often overshadow the weaknesses of the system, which included grade repetition and a high dropout rate.<sup>6</sup> These problems were highlighted at the 1971 First National Congress of Education and Culture, which convened in Havana in April of 1971 with 1,781 delegates. To solve the series of failures in the system, the primary remedy was to devote more resources to the proper training of Marxist teachers. Part of the problem was the acute need for teachers, which

required continued reliance on *maestros emergentes*, young teachers trained after completing the ninth grade. In addition, beginning the 1971-1972 school year, the Ministry of Education began operations through an intricate bureaucracy with multiple departments, each designated to handle every possible component of the educational system.<sup>7</sup> These reforms must not have seemed enough to Castro, who added criticisms during a speech to the Communist Youth Congress in 1972. He complained that the educational system was not producing graduates in the professions needed for economic development. Too many graduates in the humanities were not integrating themselves and contributing to the economic needs of the country. He wanted all schools to include the work-study component. The signals from the top were clear, and the Ministry of Education set out to revise its plans in time for approval at the First Cuban Communist Party Congress in 1975.

The **Plan de Perfeccionamiento del Sistema Nacional de Educación** (Improvement Plan for the National Education System) of 1975-76 provided the guidelines to improve the quality of education in closer association with the Communist Party in order to better satisfy economic and ideological goals. The Congress also promulgated a new constitution with specific references for education.<sup>8</sup> The 1976 charter declared Marxism-Leninism the only acceptable ideology.

The revisions of the 1970s allowed Cuban education to offer more possibilities for technical training and study in Eastern bloc countries. Programs in economics also sprung up.

But the ideological price was high. Thought control increased with additional mechanisms to monitor Marxist orthodoxy in the classroom. These mechanisms ranged from school records on student revolutionary activism and discipline to supervision of faculty by militant specialists. While Cuban publications, such as *Educación*, ran (and still run) articles recommending parental involvement in Cuban education, the government continued to control the relationship between parents, community, and school. All communication is channeled through mass organizations and directed by political personnel. British educational analyst Mark Richmond finds that:

...the full flavour of the Cuban educational model would be lost without mentioning the active participation of the whole community in performing a broad, diverse range of educational tasks and duties.



This participation is channeled through a number of political and mass organizations, including the Cuban Communist Party, the Young Communists, the Pioneers, student federations, trade unions, the Federation of Cuban Women, the School Councils, the Committees for the Defense of the Revolution, and the Local Organs of People's Power. This widespread, popular involvement is an essential aspect of the Cuban educational model, being a vital expression of the attempt to break down the barriers between school and society.<sup>9</sup>

While Richmond can't avoid enthusiasm about the Cuban model's access component, he recognizes that it can be interpreted as "a recipe for totalitarian education" or as "national liberation."<sup>10</sup> He is disappointed that by the mid-1980s, democratization of education was not manifesting itself in decision-making processes at the local levels. By then, rather than decentralizing policy, the leadership launched a Rectification Campaign and the coercive force of the Cuban state was once again repressing its educated population to counteract the Soviet *glasnost*.

During its third decade, the Cuban Revolution provided a picture to the world that all was well in its educational system. Sending teaching brigades to Angola and Nicaragua and physicians and engineers the world over, Cuba appeared to be an educational power. At home, by maintaining its initial strategy of reaching everyone, literacy was a reality throughout the island and schooling through the ninth grade was available to all. Nevertheless, the leadership was concerned. Economic assistance was dwindling; troops from Africa were coming home and needed job placement. Before the end of the 1980s, admission to the university was reduced by 50 percent and rejected candidates had to settle for vocational or technical schools. To Castro, the problem was more political than economic. He saw failure in the product the schools delivered. Marxist pedagogy had not sufficed to create the new man seeking to fulfill revolutionary objectives and develop the national economy. Castro expected more students to be like Felipe Pérez Roque, then secretary-general of the Federation of University Students (**Federación Estudiantil Universitaria** – FEU) who had stated that "the university is for revolutionaries...The dialogue is with the revolution and for the revolution. He who goes beyond those limits is not talking to us."<sup>11</sup> Castro wanted the university students to go to the factories or fields:

... a historian — a fine, interesting profession — can be trained in a directed reading course, but that kind of course can't train a single agricultural worker or produce a single bunch of bananas or grow one pound of sweet potatoes, while the Güira de Melena enterprise, with 4000 hectares of land, has 128 agricultural workers!<sup>12</sup>

Ultimately, Castro's combined praise and chastisement of revolutionary education amounts to what analyst Jean-Pierre Beauvais has described as "the most striking of the many contradictions of the Cuban revolution — high political consciousness and low 'economic consciousness' of the masses."<sup>13</sup> Beauvais's critical eye allowed him to analyze the achievements and failures of the Cuban revolutionary experiment, but such broad analyst is rare among those who have visited the island over the decades. The Cuban Revolution often succeeds in presenting an image that dismisses the flaws in its educational system as matters that would be overcome with persistence in existing methods until a new generation internalized its ideology.

## **Education in the 1990s**

Conditions after 1991, following the collapse of the Soviet Union, have blatantly exposed the weaknesses of the Communist world and have significantly thwarted the Cuban regime's ability to promote itself. Some of us would characterize the post-Soviet period as one of retrenchment but the government called it the "Special Period in a Time of Peace." Two features that the government maintained in its educational policy have been to continue (1) promoting Marxism-Leninism, in spite of the changing circumstances in the nation and in the world;<sup>14</sup> and (2) the allocation of about 10% of the Gross Domestic Product to the education sector. As the national budget decreased, so did that for education in absolute figures, but after 1996, expenditures for education have risen.<sup>15</sup>

The loss of Soviet subsidies diminished investments in domestic services and forced the government to legalize possession of the US dollar. The Special Period's immediate manifestation in the classrooms was the reduction of school supplies and textbooks; support programs, such as school lunch and adult enrichment education, were indefinitely suspended. The most damaging manifestation came from the *dollarization* of the economy and the promotion of foreign tourism. An average monthly

teaching salary of 350 pesos has the market equivalent of twelve U.S. dollars, contributing to the exodus of teachers from the profession, as diversion to the tourist economy provides the needed supplement to a teacher's income.<sup>16</sup> Ironically, the revolution's greatest accomplishment in education was its reach-out programs into the rural areas, but these are precisely the regions most affected by the decline in the number of teachers. The countryside, where access to the tourist economy is least likely, can only attract the most devoted teacher.<sup>17</sup> Just as the dollar economy lures teachers away from the profession, students are also lured away from the academic tracks by the emoluments of the tourist economy.<sup>18</sup>

Policies that helped the government control education and improve statistics in the early days of the Revolution have eventually become double-edged swords. While damages may have been minimized by the structured and controlled nature of the educational system, its rigidity has also backfired. First and foremost, the ideology-driven system purposely sought to remove the family from the educational enterprise, unless contact was made via official structures. From nursery to higher education, the revolutionary government promoted an educational system divorced from direct home influence, emphasizing the paternal role of the state in providing for its people. While the Constitution and the media claim that the family must be directly involved in children's education, this involvement must be channeled through official organizations. During the Special Period, at a time when educators have been frequently abandoning the profession, the lack of parental pressure on the system and on the children to attend school and study has often been absent. Also backfiring is the state's paternal role in assigning rewards, fields of study, and employment guarantees to graduates. Having absorbed the traditional individual decision-making process by planning and promising placement, the state finds itself unable to deliver positions to many graduates due to the changing global economy, its legalization of dollar transactions, and a growing younger population that it can no longer deploy in Third World liberation wars as it did during the 1980s.

The Cuban Ministry of Education hosts a major international congress every other year, which it co-sponsors with UNICEF. The language used in these **Pedagogía** congresses is soft on Marxist jargon. However, at the most recent gathering in February 2003, the Minister of Education dwelt on the US economic embargo as an issue limiting the Cuban class-

room.<sup>19</sup> References to the Special Period do not lead Cuba to announce changes to its educational master plan.<sup>20</sup> The continuity of strategy and methods may suggest recognition of success,<sup>21</sup> certainly supported by the statistics. A United Nations Educational, Scientific, and Cultural Organization (UNESCO) study comparing several Latin American systems showed Cuban third and fourth graders held the highest level of achievement in mathematics and language skills.<sup>22</sup>

The **Pedagogía'99** document begins with references to the difficulties brought about by the loss of Soviet aid and continued United States hostility, but it denies the failed goals of the revolutionary educational ethic. The document omits references to the lack of productivity of the labor force and to decreased admissions to higher education, except in medical technology, reflecting the few viable sectors of the economy and the lesser level of preparation needed for agriculture and tourism. **Pedagogía'99** stands out for its sophisticated theoretical content, particularly in reference to teacher training. The document claims that after 1991, all teachers had completed the college preparatory secondary school prior to admission to a five-year professional teaching program. The *maestros emergentes* still in the system were expected to complete pedagogical training toward a higher education degree. To allow teachers to pursue postgraduate work, sabbatical leave was authorized.<sup>23</sup>

The **Pedagogía** congresses illustrate how Cuba continues to showcase its educational system through international fora, as well as through pedagogical publications and guided tours with "limited access to archives and academic settings"<sup>24</sup> to visiting scholars. The Lenin College Preparatory School in Havana is showcased for the quality of its education, and visitors are shown the competitive entrance exam required for admission.<sup>25</sup> Consequently, most analysts continue to consider Cuba's educational system one of the great success stories of the Cuban Revolution. To provide a recent example, a study published by the World Bank begins with the following summary:

The record of Cuban education is outstanding: universal school environment and attendance; nearly universal adult literacy; proportional female representation at all levels, including higher education; a strong scientific base, particularly in chemistry and medicine; consistent pedagogical quality across widely dispersed classrooms; equality of basic educational opportunity, even in impoverished areas, both rural and urban.<sup>26</sup>

However, conditions in Cuba during the “Special Period” have eroded many of the conditions that facilitated those educational gains, while accentuating its weaknesses. Thus, while education continues to be promoted by the 44-year-old regime as a major revolutionary accomplishment, along with universal health care, these pillars of legitimization seem to be corroding at the base.<sup>27</sup>

## **Current State of Education in Cuba**

Readers of the Cuban official newspaper *Granma* in 2002, whether the international or the daily edition, can arrive at a variety of conclusions concerning the state of the Cuban educational system. The government’s commitment to invest in education seems unalterable in spite of recent setbacks, such as a debt crisis that interrupted crucial Venezuelan oil deliveries for over four months and the decline in international tourism. Various newspaper articles have emphasized that Cuba will reach a 20 student per teacher ratio in 2003. Castro has personally inspected school sites undergoing remodeling in the Havana area to be ready for the next school year.<sup>28</sup> During a speech to 90 graduating teachers, Castro praised them for “recreating the history of the literacy campaign.”<sup>29</sup> Celebrating his 76<sup>th</sup> birthday on 13 August 2002, he gave a long speech praising the 746 refurbished and 33 new schools in the Havana area.<sup>30</sup>

In response to “the putative loss of the teaching vocation among the young,”<sup>31</sup> Castro praised the professional *emergente* programs to graduate students with only a ninth grade education. He mentioned that by September 2002, another class of 6,000 elementary school teachers would graduate and a new campus, Escuela Salvador Allende, with the capacity to prepare 4,500 future middle school teachers from the provinces would be ready. The program consists of one-year teacher training courses to the unemployed population. “Some 86,000 unemployed 17 to 29-year-olds from all over the island are to be incorporated into retraining courses, receiving a monthly stipend.” Castro’s goals include adding 5,000 teachers to the middle school grades by Fall 2003. The average age of these new teachers is 19.

When the school year began on 16 September 2002, the old Havana municipality of El Cerro was to have five new schools added to the 20

undergoing renovations.<sup>32</sup> The Frank País Brigade from Santiago de Cuba was working to refurbish a house into one of the new schools in the neighborhood with the assistance of workers released from their regular jobs. At the nearby Reinel Páez School, 50 workers from seven state enterprises were laboring to remodel this elementary school for 770 students. The *jefe de obra*, the person in charge of the works, was the secretary of Communist Party at the nearby beer-bottling plant La Polar. To celebrate the 42<sup>nd</sup> anniversary of their establishment, the **Comités de Defensa de la Revolución** (Committees for the Defense of the Revolution — CDR) were to spend two Sundays in August getting their corresponding neighborhood schools ready.<sup>33</sup>

At midnight on 10 June 2002, President Castro made an appearance at the Reinel Páez School, to the surprise of workers who had stayed late laboring with the help of neighbors and the school's principal and teachers, some "covered head to toe with cement and paint," according to the reporter who covered the unexpected encounter for *Granma*. All cheered the revolution's chief; he was particularly interested in asking them about the students' improvement in spelling as a result of new computer software.

## News Analysis of the Cuban Press

The Battle of Ideas mentioned in the *Granma* articles is the revolution's euphemism in a battle for the minds that dates to the first days of the revolution. Education serves to mobilize the Cuban population, as the literacy campaign proved so well in the early days of the revolution. The Summer 2002 pro-education drive tailed the massive June signature campaign launched to counterattack and shelve the Proyecto Varela, a constitutional initiative to liberalize Cuban society. Thus, the school campaign served (and continues) to maintain the victory-of-socialism euphoria that Castro has always been so adept at conducting.

The El Cerro article in *Granma* is a great reminder of the fiscal profligacy of revolutionary initiatives. About 22,000 workers and *microbrigadistas* were reassigned to the Havana school project between 29 June and 13 August 2002.<sup>34</sup> There is no consideration of cost effectiveness when displacing workers during their working hours from labor at which

theoretically they are competent and productive to construction sites where they are amateurs. The safety of the school buildings is apparently not a consideration; there are no references to building inspectors. Also inefficient is the mobilization of working brigades from distant regions, creating additional expenses of transportation, room, and board.

The competency of management also deserves questioning when a worker at a beer plant is entrusted to direct a construction project. Membership in the Communist Party is deemed worthier of recognition than competency in the construction industry.

While there is a constant and growing need for good teachers in Cuba, one can only question the quality of instructors with only one year of training. Many shortcomings of the system in the early days of the revolution had been attributed to unqualified faculty, and the Ministry of Education had made it a goal to raise the standards. After 1991, it had required five years of college training for all teachers. The policy reversal is attributed to the need to improve the teacher-student ratio; there is no reference to the exodus of teachers away from the profession, except for Castro's own question of it during his August 2002 speech. However commendable the ratio of 20 students per teacher may be, experience has shown the negative long-term qualitative effect of a quantitative quick fix.

Castro is quoted saying that 86,000 youngsters in Havana who neither worked nor studied had been enrolled in **Escuelas de Superación Integral** (Schools for All-Encompassing Development).<sup>35</sup> What were these many young people doing that they were not in school, which is tuition-free, when the state acknowledges that they were not in the labor force?<sup>36</sup> How many of these students can be expected to stay in school? Can inexperienced teachers, many with no more than nine years of basic schooling and earning about US\$15 a month, be expected to perform academic miracles?

While *Granma* has failed to deal with the issue of disaffected youth, an article in *Tribuna de La Habana* provided some pointers. A middle school teacher complained that 25 percent of the students who had to attend the required 45-day *escuela al campo*, the agricultural work component of the core curriculum, filed medical certificates excusing them from laboring in the countryside. The teacher/commentator asked: how could it be possible that 25 percent of the 13- to 15-year-olds in Havana

were not in good health, given Cuba's health statistics? In addition, parents continued to visit the camp and retrieve their children over the "family drama of a *muelita cariada* (tiny molar cavity) or the first sneezes that signaled an oncoming cold."<sup>37</sup> In *Tribuna*, an official publication, the teacher blamed it on parental overprotection and advised parents against such behavior that inhibits character development.

Writing for the Catholic magazine *Espacios*, Julio Ramón Pita blames the proliferation of medical certificates to waive the *escuela al campo* requirement on the grueling and promiscuous conditions that adolescents find themselves in the countryside camps. Not only are food and living quarters inadequate and work demanding under the summer sun, but for teenagers without family support and controls, promiscuity is rampant. Most who have lived through the experience attest to the uncivilized conditions of this educational experiment.<sup>38</sup> The *Espacios* reporter argues that parents should be polled so that for once their opinions could be taken into consideration and participation in the countryside camps be considered voluntary.<sup>39</sup>

Most of the young people the government wants to enroll in one-year teaching or nursing programs come from the population that literally dropped out of middle school to avoid attending the countryside camp, or that returned from the camp without a career alternative. The possibilities of entering the *preuniversitarios* (college preparatory schools) are limited; only a few of those who take the entrance exams make it into elite schools where the children of Communist Party members are well represented. In the absence of strong family values, those who are not particularly strong academically or related to the *nomenklatura* compose the population most likely to seek access to the tourist dollar on the street, increasingly via prostitution.

*Granma* has not featured articles on the lack of maintenance of school buildings throughout the island or on reconstruction comparable to that going on in Havana, although Castro often mentions that soon the efforts will be extended to other provinces. According to *pedagogo independiente* Núñez Martínez, only Havana and a few other places, such as Cienfuegos and Cárdenas — areas with more tourist traffic — have been privileged to receive construction materials; coming from the Bayamo-Manzanillo area, as Núñez Martínez defiantly refers to Granma province, he has not observed comparable school reconstruction initiatives in



Cuba's eastern region.

In contrast to the testimonies of Juan Carlos Núñez Martínez and others, Robert Johnston, writing for *Education Week*, was well-impressed by the rural schools he saw during a trip to Cuba in February 2003 (to attend the Pedagogía'03 International Congress) when he drove around the Ciénaga de Zapata, the swamp area about 30 miles south of Havana, not a tourist destination. He visited the Escuela Claudio Argüelles which services eight students in a "two-room cinder block school, though lacking in reliable electricity, has a computer, a television set, and a video player powered four hours a day by two solar panels."<sup>40</sup> He then visited the Escuela Primaria Iluminado Rodríguez, "a jewel... a model for the primary schools the government hopes to build... fresh paint, shiny tile floors, and spacious classrooms, each of which has an adjoining small plot of land for gardens or play."<sup>41</sup> The US journalist was given the school tour by the regional director of schools.<sup>42</sup>

Havana will soon host the V Cuban Communist Party Congress, bound to attract much coverage by the international media. In December 2002, the Ninth Congress of the Sindicato Nacional de los Trabajadores de la Educación, la Ciencia, y el Deporte (National Labor Union of Education, Science and Sports Workers) met in Havana.<sup>43</sup> The Pedagogía'03 Congress attracted educators from all over Latin America in February 2003. During the aforementioned speech on 13 August 2002, Castro said the reason Havana schools have been the focus of attention is that the children of Santiago de Cuba knew twice as much as those of the nation's capital. The latter knew twice as much as the children of Latin America, according to studies he did not specify. He felt the Havana figures had to be changed regardless of the sacrifices.

Perhaps a more disturbing sin of omission is the Cuban press's failure to analyze why hundreds of schools in the capital needed major repairs that required working brigades. Lack of respect for public property and vandalism are not topics for news features on the schools where new socialist men are formed.<sup>44</sup> Independent journalists alone report on the lack of civic values.<sup>45</sup>

I could not find information in *Granma* on the *preuniversitarios* run by the Ministry of the Armed Forces (MINFAR) and the Ministry of Interior (MININT). These schools are known for training the cadres of state security. The MINFAR sponsors one school in each of the 14

provinces, all named Escuelas Camilo Cienfuegos. The MINFAR does make references to its educational programs in literature such as the magazine *Verde Olivo*, but the MININT is more secretive.<sup>46</sup>

It is difficult to ignore the choreography behind Castro's surprise visit to El Cerro. There were over 50 workers, including the *jefe de obra*, laboring past midnight after a long summer day they had supposedly already spent at the site, on the same night the principal and others connected with the school also chose to volunteer their services. Conveniently, a *Granma* reporter was at hand, and electricity was readily available during the hour Castro spent inquiring about the educational facilities in the neighborhood. That there be no doubts in a reader's mind, the pictures portray a grateful crowd fascinated with their leader. "This is a *tribuna abierta* (town hall meeting)!" a young man told the reporter, alluding to Castro's openness and rapport with his people.

The above news analysis leads to the conclusion that it is Castro who is recreating the history of the literacy campaign. But by far the most ambitious educational goal Castro revived during the summer of 2002 was his promise that every student would have access to a university education. "We're not talking about the universities in the plural, but just one, because the whole country will be one single university."<sup>47</sup> This is not a new idea. During the annual speech to commemorate the death of student leaders during the struggle against Batista on 13 March 1969, Castro had promised Cubans the "universalization of the university."<sup>48</sup> As a slogan meant to capture the dreams of the first revolutionary generation, it proved effective. Now he speaks of "turning the country into a university, into a gigantic factory of professionals and intellectuals, [a country] whose major source of wealth will be knowledge."<sup>49</sup> Those who know of the inability to attain this goal three decades ago realize this is empty rhetoric.

## **Challenges from Within**

The manifestations of a civil society that challenges the establishment are questioning the revolution's legitimacy. The formation of groups and associations that lack official approval demonstrate the population's need to salvage society in ways the government seems unable to deliver.

Among these many dissident groups, three are directly involved with the rehabilitation of education: (1) **Proyecto de Bibliotecas Independientes** (Independent Libraries Project); (2) **Centro Católico de Formación Cívica y Religiosa** (Catholic Center for Civic and Religious Formation) of Pinar del Río, in Cuba's westernmost province; and (3) **Colegio de Pedagogos Independientes de Cuba** (Cuba's Independent Teachers Association). Their public actions and statements offer much insight on the rehabilitation of education in a transition era.

### *Independent Libraries*

Making a public appearance at the Havana International Book Fair in February of 1998, Castro explained, "In Cuba there are no banned books, rather there is no money to purchase them." It was the excuse utilized by Berta Mexidor Vásquez, an economist in the eastern province of Las Tunas and mother of two, to establish an independent library in her own home, a place where Cubans without the money to purchase books could access any literature. Placing a sign on their door with Castro's own words of "no banned books" as the justification for no censorship, Mexidor and her husband, Ramón Humberto Colás Castillo, established the *Biblioteca Independiente Félix Varela* to offer their neighbors the opportunity to reach opinions freely without being bound to one belief. Donations of reading materials poured to their home.<sup>50</sup> Before 1998 ended, 13 independent libraries were offering unrestricted reading materials throughout the island nation. It was a matter of time before these libraries offered discussion groups, activities for children, and provoked the government into opening official neighborhood libraries and harassing the unofficial initiative.<sup>51</sup> Colás and Mexidor sought political asylum in 2001. By end of 2002, 103 independent libraries were operating in Cuba with 182,715 registered readers.

While most independent libraries have been named after Cuban luminaries of the formative nineteenth century, some have defied censorship even further. Case in point: in 2001, a library was established in Puerto Guayabal, in the province of Las Tunas and named after proscribed Cuban novelist Reinaldo Arenas.<sup>52</sup>

The interest Cubans have manifested for the independent libraries has exposed the search for alternative ideas and free information of individuals in a Marxist-Leninist society. Ramón Humberto Colás, a psychologist

by profession, who launched the movement with his wife Mexidor, believes that at the root of his fellow Cubans' response to borrowing independent library books is a search for spiritual elevation. To him, the most devastating effect of revolutionary education is its lack of ethical context. He sees women, in particular, as much more vulnerable to living in a state of amorality because they are more targeted for prostitution than men. The lack of self-esteem he observed in women, some in their early teens, is the most blatant sign of Cuba's need to rehabilitate itself through a value-defining education. He believes the independent libraries can continue to open up doors for those who search.

Finally, Ramón Colás considers that all tasks to rehabilitate Cuban education must add up to one objective: an education that allows Cubans to learn about themselves so they can write their own history. At first, the statement seems arcane, but it encloses remarkable insight. Cubans are taught a history packed with Marxist jargon but in which even Marx's dialectical materialism is distorted to justify the Revolution of 1959. Figures lose historicity when they become pre-figures of Castro.<sup>53</sup> Time loses chronology when Castro declares that the Ten Years' War that began in 1868 lasted one hundred years and all the books in Cuba had to be adjusted to fit this thesis.<sup>54</sup> If Cubans could research their past and teach it to their children without being bound to one official interpretation, it would be the clear sign that Cubans were being educated to think and make choices for their island nation.

### *A Church-based Civic Movement*

Dagoberto Valdés Hernández, an agricultural engineer and father of three, founded in 1993 the Centro Católico de Formación Cívica y Religiosa and began the publication of *Vital* in 1994 with the support of his diocese and international organizations, such as the Konrad Adenauer Foundation.<sup>55</sup> The Center sponsors several focus groups: a group of economists who promote that "each citizen be protagonist of his own familiar, social, and national economy;" a group of educators who offer workshops on "academic, ethical, and civic education" to eighth and ninth graders; a computing group to train those without other access to computer technology; and a civic consultation group that sponsors conferences and works providing "juridical, psychological, ethical and civic advice."<sup>56</sup> In addition to the bulletins that each group produces, the journal *Vital* deals with

many of the social and cultural issues facing Cubans today.

The government has harassed Valdés for his activism. In 1991, he became president of Pinar del Río's Tobacco Industry Scientific Council, an important position because Cuba's best cigars originate in this region. The government reassigned him in 1996 to a weed-picking brigade. The latter appointment has not kept him from editing *Vitral*, which is accessible electronically.<sup>57</sup>

Valdés often writes about education. The following selections are from a *Vitral* editorial:

...[In Cuba] great efforts have been made to assure that public instruction reaches everyone. The problem here is different: Cubans cannot choose the philosophical position, the pedagogical methods, the religious orientation, or the type of school that we want for our children.

In exchange for mass access, we have given up our personal responsibility to educate. In exchange for free access to instruction, we have not exercised the freedom to choose the type of education. Whenever we express that this is a problem, we are told that we should be thankful for the opportunity to study for free. In exchange for no expenses, we have disregarded quality.

Free services exact a price in Cuba: be grateful and faithful. Gratitude is fine; it is good to be grateful and ingratitude is a form of human miserliness. But assistance that creates dependency is not liberating but enchaining; it restrains with invisible bonds, which are crueler because they are subtle; it exchanges liberty for security. It turns man into a prisoner of his own fear to lose the few securities he has been given. Many prefer to survive and have something than to take control of their lives with an independence that always carries risks.

We would not want the brutal inequalities that affect people in other countries under other systems. Regardless, inequalities come our way and not in exchange for more liberty and responsibility, but imposed by economic mechanisms that make us face the worst of capitalism and the worst of socialism. The worst of socialism is the lack of personal liberties, the difficulty to choose, not so much what we can do but what we would like to do. The worst of capitalism is found in those social injustices that breed inequality.

The essential problem of education in Cuba is not access to instruction but its lack of pluralism as a result of its excluding monolithic ideological character. In other words: while it is true that everyone has access to instruction, parents cannot choose freely the type of education they consider best for their children.

[...] To choose between a paternalistic, manipulative education and a liberating pedagogy that respects the dignity and the rights of the person.

A paternalistic education guarantees that the “father-State” will provide all of its “children-pupils” with secure instruction whose objective is that they repeat and continue ideas and attitudes identical to those of the older “children-pupils;” this also happens in the midst of an authoritarian family, or in a paternalistic religious institution without member participation. It is a transmission cord that pushes and reiterates the same movement at the same pace. It does not educate persons but repeating machines. It assures itself of a blind or naive faithful following, but it turns citizens into burdens of the State, the Church, and the family — an amorphous mass without willpower making inertia a style of daily life.

A paternalistic and manipulative education provides security today and uncertainty tomorrow because when the time comes to make a decision using one’s own head without tutelage from the top, the head rolls in indecision and corruption.

In contrast, a liberating and pluralist education is risky and insecure today but the guarantee for civic maturity and the autonomy of the individual and civil society tomorrow. Like the risk run by a child taking his first steps, we all know that no one would be able to walk with his own two feet without that previous risk. What are we surprised about when we see people and groups in moral and social stagnation?

A liberating education is not an opening to libertinism but to personal and social responsibility. Only he who is free to choose can accept responsibility for his actions. A pluralist education is not an opening to moral relativism and to an “anything goes” attitude. It lets us discover the richness of diversity, and we respect it as a guarantee that we appreciate the rights of each individual.

Each Cuban mother and father has the right to choose between these two pedagogical styles... Let’s not fool ourselves: the character of our youth is weakened by the routine of only one educational option. Life cannot be enriched without debate. The national soul is dehumanized by the existential tediousness of one ideology. Without an educational system that would allow a real possibility to access some religious inspiration, the human spirit dries up “because [as José Martí said] there is nothing in it to nurture virtue.”<sup>58</sup>

While this *Vitral* editorial is representative of the educational concerns of dissident thinkers in Cuba, other publications also express similar concerns. For example, several articles in *Espacios* focus on similar topics, such as the need for parents to choose the school for their children, the need for ethics and civic education, and the damage of ideology in the classroom.<sup>59</sup> The **Equipo Promotor para la Participación Social del Laico** (Team for the Promotion of Social Participation of the Laity) of the Archdiocese of Havana publishes *Espacios*.

## *Independent Educators*

The third dissident group is the Colegio de Pedagogos Independientes de Cuba, hereafter Colegio, established in June 1996. After six years, it claims to represent at least 300 schoolteachers throughout the island, many of whom have ties to other dissident groups as well. For example, Moisés Leonardo Rodríguez Valdés, currently a vice-president, is the founder of **Corriente Martiana** (Martí's Current), a group of intellectuals who, by following José Martí's thought, run against the stream of official ideology. Some are teachers in the school system, but many, as its president Roberto de Miranda,<sup>60</sup> were forced to leave the profession for ideological reasons and remained active teaching only through private initiatives, such as the *salas de repaso* (drill and tutor programs) and activities held at independent libraries.

The evolving platform of the Colegio openly challenges the Cuban educational model established by the revolution, one whose goal is to form *un hombre nuevo*, a concept based on Marxist-Leninist ideology and articulated by Che Guevara.<sup>61</sup> Alternatively, the Colegio proposes a model to educate citizens for a Nueva República Martiana, a new republic based on the thought of José Martí, unquestionably the most revered Cuban national figure. The model adheres to the UNESCO guidelines on Human Development but incorporates Martí's conception of a citizen in a free society. To support its proposal, the Colegio often quotes from Martí's writings on education and refers to the ideas of other Cuban foundational figures, such as Félix Varela, José de la Luz y Caballero, Ignacio Agramonte, and Enrique José Varona, among others. This is not an innovation in Cuban pedagogical thought: Cuba's official publications make frequent references to nineteenth-century thinkers, even when euphemisms distort the intent of Cuban writers inspired by Western liberal thought.<sup>62</sup> Chart 2 describes the "man" each system expects to educate:

<p style="text-align: center;"><b>The New Man (proclaimed by the Revolution)</b></p>	<p style="text-align: center;"><b>The Citizen of the New Republic (envisioned by José Martí)</b></p>
<p><i>-is subjected to a single ideology.</i></p>	<p><i>-can freely choose any ideology.</i></p>
<p><i>-is subjected to a single self-proclaimed scientific world view.</i></p>	<p><i>-can freely arrive at his own world view.</i></p>
<p><i>-is offered only one possible political affiliation.</i></p>	<p><i>-can decide to identify with a political persuasion, change it, or abstain entirely.</i></p>
<p><i>-has his individuality disregarded that he may submit himself unconditionally to orientations claiming to pursue the general welfare.</i></p>	<p><i>-is educated for the total development of his individuality that he may contribute to the common good.</i></p>
<p><i>-is improperly taught to identify and relate homeland, revolution, and party, among other concepts, as part of a manipulative strategy.</i></p>	<p><i>-is taught the differences among concepts such as homeland, revolution, and party, according to their content and scope, as part of a liberating methodology.</i></p>
<p><i>-is taught values at odds with internationally recognized ethical and living norms, such as unconditional allegiance to one party, revolutionary intransigence, violence for revolution's sake, and class struggle.</i></p>	<p><i>-is taught values in line with universally recognized ethical and living norms, such as tolerance, friendly foreign relations, and dialogue and mediation to solve conflicts and reconcile differences.</i></p>
<p><i>-is removed from the primary role traditionally assigned to the family in the children's education. Parents cannot choose the type of school they prefer for their children.</i></p>	<p><i>- is expected to play a major and decisive role in his children's education. Parents choose freely the type of school they prefer for their children.</i></p>

Chart 2. Cuban revolutionary pedagogy vs. José Martí's pedagogy<sup>63</sup>



Clearly each system seeks to educate a person who can contribute to the perpetuation of a particular order, respectively, the *hombre nuevo* to the socialist state and the *ciudadano* (citizen) to a proposed (and therefore still idealized) new republic. The figures to be emulated are well established in each case. Cuban children today begin each school day with an oath of allegiance:

*Pioneros por el comunismo, ¡seremos como el Che!*  
(Pioneers for communism, we will be like Che Guevara!)

In contrast, the unofficial Colegio model seeks to raise a follower of José Martí by promoting this thinker's ideas on education and his plans for a socially just and independent Cuba. The use of Martí to satisfy a nation-building educational agenda predates the Castro revolution and has not escaped it without a Marxist twist.<sup>64</sup> His apostleship extends to the Cuban Constitution of 1976, further emphasized following revisions in 1992.<sup>65</sup> The Colegio's reliance on Martí's thought to articulate its goals reflects a recovery effort from what the dissident group perceives to be the national tradition and Martí's international standing as a follower of the Enlightenment tradition that manifested itself in Latin America's emancipation from Spain.

Chart 3 compares and contrasts the civic orientation that each system promotes in its educated man:

<p style="text-align: center;"><b>The New Man (proclaimed by the Revolution)</b></p>	<p style="text-align: center;"><b>The Citizen of the New Republic (envisioned by José Martí)</b></p>
<p><i>-is part of a social project imposed from outside and from above by an “elected” class beyond his say.</i></p>	<p><i>-should be part of a social project conceived, elaborated, and controlled by his elected representatives, over whom he exercises the power of the ballot box.</i></p>
<p><i>-is guided by government officials who are themselves guided by the only party.</i> (From 1992 Constitution, I, Article 5)</p>	<p><i>-freely elects his representatives among candidates from several political parties.</i></p>
<p><i>-is subject to a paternalistic regime that determines the distribution of national wealth, deepening the individual’s dependence on the government.</i></p>	<p><i>-lives according to his effort and initiative, receiving only an adequate share of the national wealth.</i></p>
<p><i>-cannot decide by himself on a course of action for himself or society.</i></p>	<p><i>-continuously makes decisions that affect him personally and socially.</i></p>
<p><i>-is expected to belong to social and political organizations that are sanctioned by the state to support its interests.</i></p>	<p><i>-decides whether to belong to any, or many, of the independent social and political organizations that emerge through the natural right of association.</i></p>
<p><i>-must live according to officially imposed social norms, binding the individual to a “double morality” or to an amoral state.</i></p>	<p><i>-must live according to naturally developed social norms, which are sanctioned by a moral standard and a judicial system, independently of those powers subject to a rule of law.</i></p>
<p><i>-his rights and individual liberties are interpreted, regulated, or violated by the state according to its interests.</i></p>	<p><i>-his rights and individual liberties are openly interpreted according to the law; citizens, groups, and the judiciary encourage their enforcement and condemn their violation.</i></p>
<p><i>-his education focuses on confrontation, class struggle, revolutionary violence, Intolerant actions and verbal attacks toward those of a different mind through the use of epithets such as scum, imperialists, and counterrevolutionary.</i></p>	<p><i>- his education focuses on love as proposed and practiced by José Martí, tolerance, informed dialogue, and respect for the rights of others in order to live in peace.</i></p>

Chart 3. Cuban Citizen as a new socialist man vs. as envisioned by José Martí<sup>66</sup>

That those inside Cuba today who chose to analyze conditions independently and to propose educational reform for the Cuba of tomorrow should be turning back to the thought of Cuba's founding fathers, and particularly to the writings of José Martí, is significant after 44 years of Marxist-Leninist ideology. Would not a new generation want to test new ideas and methods, even untested theories? Shouldn't the ideas of the past be held responsible for the conditions that brought about the Revolution in the first place and thus be unattractive to those who advocate change? Why risk recreating even some of those preconditions? The schemes recommended by the Colegio laud the pre-1959 educational efforts, social values, and, as such, may even be described as reactionary. After so many years, can they be attributed to nostalgia?<sup>67</sup> Those interviewed often spoke of the activities and type of education about which their parents and grandparents still reminisce from their school days in the 1950s. Those who want to can hear an oral history of Cuban schools before the revolution. For example, *pedagogo independiente* (independent pedagogue) Juan Carlos Martínez Núñez of Bayamo told me how until 1960, the local public secondary school, the Instituto José Antonio Saco, held a weekly civic program to which parents were invited. Born in 1954, he only knew of these programs from hearsay. Now, in defiance of the local authorities, he tries to conduct a special activity every Friday at a cultural center he runs from his own home. The center is named after Antonio Bachiller y Morales who, like José Antonio Saco, was a nineteenth-century intellectual. Along with offering art classes and assistance with homework, Núñez sponsors cultural activities with the purpose of teaching the children and their parents those elements of Cuban history deleted from the official curriculum.<sup>68</sup>

The rejection of the present plays a major role in the desire to return to a past, however idealized this past may be. When interviewing dissident teachers, I always asked them which elements of the revolutionary educational system they wished to salvage. Some were hard pressed to find an answer without conditioning it. Some praised the addition of rural schools; only the school lunch program escaped major criticism. Yet it would be unfair to consider the dissidents' rejection of the revolutionary experience strictly subjective. Their discerning analysis of José Martí's thought is remarkable, given the selective and intense use of Martí's ideas by the regime.<sup>69</sup> Castro refers to Martí as the intellectual author of the rev-

olution. Even the Cuban Constitution juxtaposes Marx and Martí as socialist models, reducing them to propaganda tools.

It is evident that the revolutionary ideologues found Martí's ideas of social justice and self-sacrifice useful, although in the Communist regime's practice, these concepts were equated with class struggle and repression. The Colegio's quest to recover Martí's original intentions and establish the republic and pedagogy that he envisioned for Cuba suggest more than a reaction to the revolution of 1959. It seeks to revive the unfulfilled national dreams that date from the early nineteenth century. After 1923, the first generation to reach maturity after independence strongly reaffirmed Martí's vision of the Cuban nation. Félix Lizaso, a member of that generation put it succinctly:

Martí wanted a republic of the people, capable of promoting economic welfare, racial equality, providing a not exceedingly literary well-rounded education, with honesty in administration and public life. [A government] focused on the country's identity searching for real solutions to its problems... But that labor for the people's redemption could not be accomplished with foreign slogans and formulas applicable to realities other than ours.<sup>70</sup>

Just as those who were dissatisfied with the state of Cuban affairs in the first half of the twentieth century looked to Martí's writings for inspiration, Cuban dissidents today continue to do so. Their rejection of the revolutionary ethos may be related to the realization that the communist regime makes a travesty of Martí's republic, the latter a value historically embedded in their hearts.<sup>71</sup> Political scientist Julie Bunck has argued that Castro's efforts to establish a revolutionary culture in Cuba have failed in spite of the suasion and coercion that have been alternatively and intensely applied.<sup>72</sup> Except in the case of sports, where both the Cuban people and the government benefited from the adoption of a revolutionary sports ethic, Bunck analyzes the revolutionary strategies to change the culture of labor, women, and youth, only to find that traditional culture resisted any transformation. In spite of all the resources that the monopoly over education allowed the government to devote to teaching Marxist-Leninist ideology, the new socialist man has not emerged. Bunck's conclusions help answer why a desire to shed the Marxist pedagogy and to recover the pre-revolutionary tradition in education in order to move forward in a different direction persists among dissident Cuban

teachers.

Transition programs in Eastern Europe and the former Soviet Union also reveal the failure of Marxism-Leninism to transform traditional cultures, however affected these cultures were left. While public awareness of those failures facilitates support for the rehabilitation of an educational system, these societies' efforts to revamp education in the post-Communist era deal with the high expectations of those awaiting rehabilitation. Any new education program in Cuba will need to address the hopes and fears of an open society, pointing to the limitations of democracy and the imperfections of the market economy. Civic education must emphasize that democracy is a process, not a new path to the utopia Marxism and its variants had promised.

Idealization of the past may be uplifting to the human spirit but, as the Romantic movements of the nineteenth century have taught all students of history, it fails to consider the shortcomings of an open society. Case in point: Dissident Bertha Mexidor, the founder of the Independent Libraries in Cuba, includes in her critique of the Cuban educational system the government's control over career tracks. She points to the disregard for the student's life interest and aptitudes — although the ideological is heavily weighed — even though there is no guarantee of a job in the field a Cuban student is forced to pursue. Her assessment of how the Cuban government plans the career map is true. But she fails to notice that even in the open market society, where a student's options for fulfilling career dreams must be weighed against the student's aptitudes and financial assets or assistance, there is no guarantee of the dreamed job after graduation. A closed society breeds such poor logic.

Mexidor's complaint originates in the realization that (1) the socialist system promises to deliver what it decides is needed, weighing ideological preferences, not what the individual perceives as his best way to contribute to society; and (2) the system cannot deliver what it promises because the social needs and the economic demands may not coincide with what the party's planners had programmed. From the above realization, this dissident was led to conclude that with the negation of (1) in an open system where the individual chooses the career he perceives to be the best, the opposite of (2) will result. The dissident thus idealizes that in an open society, all of his dreams can come true.

The case above has much in common with the documented experi-

ence of Eastern and Central Europeans. The individual wishes to live in an open society but cannot be fully extricated from the paternalism of communism. Even intellectuals like Mexidor who have consciously rejected this paternalism need to deal with the recurring patterns of thought. To those considering policy recommendations, it should serve as a reminder that any curriculum revision needs to consider the realities, processes, and history that have affected the proposed beneficiaries. The implementation of educational reforms is bound to be a long and gradual process that must adjust its tempo to the overall changes the country will be simultaneously experiencing.

## **Diagnosis**

The Cuban educational system is bound by the constraints of Marxist pedagogy and as such lacks (1) the decision-making independence to liberalize contents and methods; and (2) the capability to provide the population with the means to engage in the development of a self-sustaining economy. The latter failure is the more astounding in light of the government's efforts during the last four decades to increase worker productivity and diversify the economy.<sup>73</sup> The constraint ideological imperatives placed on these efforts helps to identify the culprit: the Cuban system resembles those of the Soviet bloc countries. Modeled after those systems, it succeeds in providing the general population with access to education and in providing scientific training to those who qualify for specialized fields. At the same time, it fails in the general quality of instruction and cost-effectiveness, issues related to its centralized ideology-driven structure. The Cuban system suffers from poor management leadership, originating in political profiling, and from an extensive bureaucracy that contributes to its inefficiency.

The lack of correlation between vocational education and the needs of the labor market is a major flaw of the revolutionary economy. This condition has intensified during the Special Period: peso salaries fail to guarantee living wages, the latter more easily accessed through low-skill participation in the tourism sector. Professionals are driven away from their posts. In the case of teachers who leave the classroom permanently or are frequently absent, education suffers directly. When middle, sec-

ondary, and college students choose to earn dollars in tourist districts rather than stay in school, education is impacted fundamentally.

A recent initiative to turn unemployed and disaffected young people into teachers by providing them with one year of pedagogical training is unlikely to result in a lasting improvement in education. More worrisome than inadequate preparation is the absence of vocation, combined with lack of monetary incentive, to be found in the *maestros emergentes*, as the new graduates are called.

The Cuban educational system continues to require monitored ideology-based curricula. All course contents and student learning experiences are affected by this limiting mandate. Inadequate learning processes decrease student learning potential. These conditions include minimal teacher-student motivation, a growing dependence on untrained substitutes, *maestros emergentes*, and student teachers. Dilapidated buildings also affect learning conditions. A major school-building refurbishing project is underway in the Havana area, well-documented in the Cuban press. Unfortunately, there is no evidence in the Cuban press to suggest that school construction and remodeling will be extended to other regions in the near future. Rural schools are the ones in most need of repairs. The repetitions of the model rural school in the Ciénaga de Zapata are still awaiting.

Difficult economic times have also continued to curtail plans to provide learning institutions with access to electronic technologies. Once again, schools in the Havana area have benefited from computer laboratories and instruction in basic usage. By September 2003, the educational television channel is expected to reach the remaining ten provinces currently without access.<sup>74</sup> Several Cuban institutions of higher learning currently offer courses online. The website of the Ministry of Science, Technology, and the Environment (CITMA) provides descriptive links to these programs and offers details for foreign students who might wish to register.<sup>75</sup> Given the limited access Cubans have to computers, these programs are directed to a miniscule percentage of the population and to foreign students who pay tuition in dollars.

Parent involvement in schools is channeled through local official organizations, stifling any community-based effort to complement child education or to demand better services from the authorities.

## Recommendations

The following recommendations are formulated on the premise that they may be of assistance to Cuban authorities who recognize the need to rehabilitate the educational system in order for Cuba to move forward from its revolutionary experience of the last four decades. While many of these recommendations can succeed on their own merits and some may only require implementation under the current system, only a global plan that includes freeing the curriculum of Marxist-Leninist ideology can truly rehabilitate the Cuban educational system.

The Russian and Czech transitional experiences of the last decade suggest that structures and schemes should not be altered too rapidly.<sup>76</sup> Cuban schools should not change grade/level relationships and general requirements until those changes first implemented can be adequately evaluated.

The recommendations are numerous and fall into five categories outlined in Chart 4. Descriptions follow.

<p style="text-align: center;"><b>Recommendations for the rehabilitation of the Cuban educational system</b></p>		
<p><u>General</u></p> <ul style="list-style-type: none"> <li>• Maintain universal access</li> <li>• Enforce equal opportunity</li> <li>• Improve quality</li> </ul> <hr/> <p><u>Administrative</u></p> <ul style="list-style-type: none"> <li>• Legalize private and religious education</li> <li>• Reduce bureaucracy</li> <li>• Enforce professional standards</li> <li>• End political profiling</li> </ul>	<p><u>Curricular</u></p> <ul style="list-style-type: none"> <li>• Free contents of Marxist ideology</li> <li>• Civic education</li> <li>• Teacher training</li> <li>• Computer education and distance-learning programs</li> </ul>	<p><u>Community</u></p> <ul style="list-style-type: none"> <li>• Parental involvement</li> <li>• Social services</li> <li>• School lunch</li> <li>• Independent libraries</li> <li>• NGO support</li> <li>• Mass media campaign programs</li> </ul> <hr/> <p><u>Executive</u></p> <ul style="list-style-type: none"> <li>• Board of Regents</li> <li>• Education as integral element of all National Reconstruction</li> </ul>

Chart 4. Outline of recommendations for the rehabilitation of the Cuban educational system



## *General*

Those seeking to rehabilitate the Cuban educational system must be willing to discern among its many features and select those elements that deserve activation and/or continued support. While a salvage operation requires more creativity and assessment than the radical demolition of the existing system, Cuban education possesses sufficient strengths upon which reformers may capitalize. It is imperative that any transition government be committed to maintain and qualitatively improve:

- (1) records of universal access through the ninth grade, no gender disparity in enrollments, and no adult illiteracy as well as support of special efforts to staff rural areas. This is sound policy, as these constitute basic educational outcomes desired by all developed nations;
- (2) guarantee of free public education to all Cubans through the ninth grade that must include special education for the physically, mentally, or emotionally handicapped;
- (3) access to any educational institution based on the student's academic record, regardless of race, age, gender, religion, or political affiliation;
- (4) emphasis on vocational and technical education for the adult and student populations;
- (5) training programs in labor-intensive sectors, such as agriculture, tourism, and construction;
- (6) computer literacy courses at all grade levels and in adult education centers;
- (7) the nutritional component: breakfast or lunch at school;
- (8) the health component: eye and hearing tests, vaccinations;
- (9) sports programs;
- (10) health education in topics that the government has ignored or downplayed, possibly for reasons of image — alcoholism, drug addiction, HIV/AIDS, venereal diseases, and domestic violence;
- (11) existing programs of the scientific-technological orientation and foreign languages; and
- (12) plans for computer classes.

## *Administrative Recommendations*

*Legalize private and church-affiliated education.* An open society must facilitate alternatives to its citizens. An all-public school system lacks the ability to evaluate itself.<sup>77</sup> The competition to provide those alternatives in education contributes to better schools and better teachers, which results in better educated students and better paid and qualified teachers. Any degree-granting institution or program must satisfy the guidelines established by the Ministry of Education.

*Downsize the bureaucracy.* Fiscal responsibility and efficiency require that the bureaucracy now administering Cuba's educational system be reduced. Currently no less than four ministries oversee the system: the Ministry of Education; the Ministry of Higher Education; the Ministry of Culture; and the Ministry of Science, Technology, and the Environment. In addition, the Ministry of Public Health, the Ministry of the Revolutionary Armed Forces, and the Cuban Communist Party, among other entities directly administer other significant educational enterprises. One cabinet post, possibly entitled Ministry of Education, could easily oversee all related matters for a nation of 11,200,000, provide a clear vision of feeder patterns from lower to higher education, and better assess and represent the population's needs when seeking financial support to carry out its mission.

Decentralization and reduction of non-teaching school personnel are necessary so that more resources are devoted to the classroom and ideological supervision ceases. The Cuban system is loaded with administrative personnel — counselors, psychologists, and *metodólogos* — whose presence is justified as “support” for the teacher and student, but whose tasks are mostly report filing, as the government has sought to establish controls over the ideological preferences of teachers and students.

Cuba needs teachers and cannot afford disgruntled unemployed bureaucrats. A policy to ameliorate these two problems would be to offer dismissed personnel from the dismantled education agencies temporary teaching certificates until completion of course work and hours of classroom experience would fully invest them as regular faculty.

*Revise teachers' contracts and salaries.* The demand for qualified teachers should be reflected in salaries and contract terms. The latter should specify qualifying conditions for teaching certification. This

should encourage many licensed teachers to return to the profession provided they obtain temporary certificates until they complete in-service courses within a designated period of time in order to be reinstated as certified faculty. Teachers' salaries should reflect formal postgraduate education, years of service, and special skills. Service in rural areas may require additional stipend or housing bonuses to encourage acceptance of teaching positions in more demanding areas.

*Enforce professional standards.* Administrative appointments in Cuba currently depend on political profile; a professional degree and teaching experience have not been prerequisites. To end this practice, a minimum number of years teaching experience should be explicitly established and must become a prerequisite for any administrative appointment, such as position of principal, vice-principal, or program director.

The standards for appointing and evaluating faculty and school administrators need to be applied according to those that even now are recommended by Cuban professionals in official publications but that are not implemented. An important step should be the re-certification of all teachers and the dismissal of all unqualified instructors within a reasonable amount of time after the announcement of availability of in-service training courses. Evaluations of teachers' community service should not be linked to official partisan activities.

The 2002 report submitted by the Colegio to the United Nations Human Rights Commission in Geneva documented over 300 cases of teachers who had lost their teaching appointments or were reassigned to difficult circumstances for ideological reasons. Those cases need to be reviewed by a school commission to ascertain whether the cause for each dismissal was arbitrary and not due to moral or professional considerations. If qualified and certified, those involved should be reassigned to positions comparable to those at the time of dismissal.

Temporary certificates should be authorized for those who have been inactive for several years but they must meet a reestablished deadline for course completion.

*Student records.* School records of students should assess and document the student academic performance and intellectual progress. Information on cognitive and psychological evaluations should be limited to the criteria established to be of assistance to educators when counseling, placing, and setting goals for individual students. Records should

be free of any political references to the student or his family, including participation or lack thereof in extracurricular partisan activities. Family record of revolutionary activism (membership in party or support groups) or its absence (children of political prisoners) as well as “counterrevolutionary” statements made by students or participation in youth organizations such as Pioneers or Communist Youth are known to form part of a student academic file.

### *Recommendations on Family and Community Environment*

*Involve parents directly in schooling decisions.* The recovery of the role of the family in child education must be the goal of an open society. Much needed is the restoration of parental authority over the type of education parents want for their children, including schools with religious affiliation, and options to accept or reject military training and boarding living arrangements. The value crisis of Cuban youth is exacerbated by the communist policy of separating child and family, in spite of all the propaganda in Cuban media suggesting the contrary. Cubans associate the required practice of sending high school students to countryside camps for agricultural training with adolescent promiscuity. Parents need to be engaged in schooling decisions, particularly those regarding work-study arrangements. Membership in any official organization must not be a precondition for community-school engagement.

*Provide counseling services.* In addition to the programs for the general population that the Ministry of Public Health should administer in the area mental health, local schools should provide psychological counseling services and support groups for students and parents as well as for teachers. While Cuban schools provide family education programs, they are limited to ideological components. Those programs reinforce the image that Cubans are provided for by the revolution, unlike the fate of the worker in a free society who must fend for himself.

Change, even when perceived as being for the better, creates anxieties. This is particularly acute when dealing with a transition from the paternalism of a totalitarian system to facing the risks of decision-making in an open society. The consequences of success or failure revert to the individual. Parents and students must make career decisions by weighing possible consequences. Decisions involve not only goals of individual betterment but also those for the welfare of the community and the nation.

As a result of communist propaganda, there is confusion between government and homeland. Under communism, Cubans have been taught to love the homeland at the expense of developing unconditional love of the government. Citizens need to differentiate and discuss ideas that question or challenge those of official authority in an environment of respect toward dissenting neighbors. They need to understand how propaganda can promote hate and anger towards those who think differently, even within family and those abroad. Perhaps the ultimate understanding amounts to the awareness that education should liberate, not make the individual feel persecuted.

*Establish a public service media campaign.* A national mass media campaign needs to promote (a) the value of an educated citizenry and (b) educational opportunities for both school age and adult populations to satisfy the career and employment needs of the developing Cuban economy. The public service campaign should stress that an informed citizen knows his rights, recognizes differences and risks before making choices, and respects the opposition to his beliefs. Because transition displaces many in the marketplace, information on new careers, training centers, and scholarships, as well as employment opportunities, must also be part of a media service campaign.

*Encourage support of education by non-governmental organizations.* Support of the existing network of non-governmental organizations (NGOs), particularly the growing network of independent libraries, translates into immediate support for educational reform. NGOs have spearheaded the movement in Cuba for alternative thought, a pillar of educational reform. Independent libraries now provide unique access to censored literature, even for children.

Long before the 1990s saw the rise of independent libraries and journalists, especially during the first two decades of the Revolution, access to censored works often came via the activities of churches, however curtailed their actions may have been. While only few Cubans continued to send their children to catechism in the Catholic Church or to attend a Protestant seminary, there is clear evidence that these institutions provided the only respite from the official literature and press available to the Cuban people. Oswaldo Payá of the aforementioned Proyecto Varela and Dagoberto Valdés, the editor of *Vitral*, are examples of Cuban youth who were first exposed to a wider world of thought through these curtailed

Catholic social services. This track record explains why today, in spite of continued restrictions, the growth of civil society is often tied to the increased social work sponsored by religious institutions of an increased number of denominations. Thus, they will continue to be well positioned to provide social and educational services to the Cuban population at large.<sup>78</sup>

The Ministry of Education holds several educational accords with international NGOs. The first NGO to establish an educational program in Cuba was the Catholic Committee for Food and Development, brought in by the United Nations International Children's Emergency Fund (UNICEF) in 1983 to sponsor special education for the blind and the deaf.<sup>79</sup> The International Congress **Pedagogía'03** was co-sponsored by UNICEF. In June 2003 Cuba co-sponsored the **Congreso Cultura y Desarrollo** with UNESCO, UNICEF, SELA, *Unión Latinoamericana*, and the *Convenio Andrés Bello*.<sup>80</sup>

Some agreements have allowed the Cuban government to continue educating Third World students in Cuba, particularly students from Africa.<sup>81</sup> As part of the United Nations system, Cuba benefits from assistance programs sponsored by UNESCO, UNICEF, and the *Organización de Estados Iberoamericanos* (Organization of Iberoamerican States – OEI), among others. It is essential that Cuba continue to subscribe to these programs in the future.

### *Recommendations on Curriculum*

*End the monopoly of Marxist-Leninist thought and jargon in Cuban educational materials.* With the exception of some university-level courses in history, philosophy, or methods in the social sciences, any other course — from pre-school to the graduate level — would hardly require linkage to Marxist-Leninist thought. All subject matters today do include such linkages, at the expense of not exposing the student to any other perspective.<sup>82</sup>

Beginning with basic learning-to-read material, new textbooks must replace the existing ones. Arrangements with publishing houses in Spain and Latin America would expedite this process in most disciplines. Cuban educators need to focus their attention on Cuban studies, especially in the humanities and the social sciences, where new texts must be introduced. Fortunately, Cuba has many qualified teachers who can be entrusted with textbook innovation. While many may still be active in the schools, many

retirees as well as faculty discharged for ideological reasons may be willing to participate in the editorial process.

*Supplement primary, middle, and secondary school curricula with civic education.* Education on respect for the rights of others, tolerance, knowledge of civil liberties, and democratic principles needs to be integrated into the regular curricula at all levels<sup>83</sup> The writings of José Martí can be useful in this effort although they, too, must be restored to their original context.

*Provide teacher training in new contents and methods.* Cuban teachers need professional training to enable them to teach the new curriculum. These courses could be applied to certification, if so determined. Following the example of the more successful rehabilitation programs in Eastern Europe, these teacher-training courses should be taught by Cubans. Those teachers who have continued to distinguish themselves in the classroom may receive the initial training courses in Cuba or abroad. Then they will become the master trainers for thousands of Cuban teachers. The selection of those Cuban teachers to become trainers may become an excellent opportunity for a new Ministry of Education to signal the system's commitment to change. By disregarding the ideological litmus tests of the past, it can select the best qualified among the nation's active faculty and include those that had been dismissed in the past.

*Develop hard and virtual library collections with distance-learning facilities.* An important component for research and for competition in a new global order, access to computers at schools and local libraries can provide much information to a population whose access to much knowledge in the world has been controlled. Cuban schools and libraries need to develop library collections. Internet access to databases and virtual collections will provide a cost-effective way to do so.

Those willing to pursue special training and explore career choices can register for distance-learning courses at authorized institutions. Distance learning can provide the best alternative for teachers in rural areas or who have difficulty combining work with a traditional classroom course. Teachers can register for courses to qualify for permanent teaching certificates and to prepare themselves for new curricula.

*Promote international exchange and study-abroad programs for Cuban college students and for teachers at all academic levels.* Cuban isolation has increased during the Special Period when the opportunities

to study in Soviet bloc countries disappeared. Cubans need to be exposed to other educational systems and to return home to offer their country alternatives to educational reform. In addition to Cuba's educational accords with many international NGOs and UN-related organizations, Cuba maintains relations with academic institutions all over the world. These accords should continue to be encouraged as way to help provide Cuban teachers with training programs in methods and new technologies. An alternative is to provide Cuban teachers with the opportunity to teach a semester or a year abroad while pursuing a course of study.<sup>84</sup>

### *Executive recommendations*

*Tie educational reform to the national reconstruction agenda.* Programs to rehabilitate the Cuban school system must be incorporated to the plans for National Reconstruction. One cannot go far without the other moving at the same pace. Long-term educational reform will be a success if it can alleviate the current social, moral, and cultural situation of the island nation; indeed, that will signal that reconstruction is proceeding. In the short term, however, the education system needs to teach Cubans how to reactivate the national economy by providing them with the tools to pursue new jobs and enterprises with better productivity.

While any government committed to reform must be generous in its education budget, it will be difficult for heavily indebted Cuba to assign sufficient funds to carry out the reforms its educational system needs. But if the government shows a profound understanding of what is at stake and transmits it to the people, allocations will materialize. Furthermore, all proposals for economic development should include an educational component, and the costs of this component should be part of the project's budget. Then, as Cuba receives much-needed international aid, funding for education will be guaranteed as a percentage of each grant or loan.

*Establish a Board of Regents.* Reforms of the magnitude recommended above require monitoring and evaluation beyond that expected of school administrators. The Minister of Education should establish an independent board of regents to oversee the adequacy, tempo, efficiency, and effectiveness of all reforms undertaken. The Board's membership needs to be limited but varied. Business and industry need to be represented as well as education specialists from different levels and areas of concern.



## NOTES

<sup>1</sup>As translated by Amnesty International, 2003, in “Individual case summaries: the faces of the dissident movement,” *Cuba “Essential measures”? Human rights crackdown in the name of security*. Section 5, profile 10. <http://web.amnesty.org/library/Index/ENGAMR250172003>.

<sup>2</sup>Miren Uriarte, 2002, *Cuba Social Policy at the Crossroads: Maintaining Priorities, Transforming Practice* (Boston: Oxfam America), 3. Note the only source for education policies in Table 1, p. 7: Cuba’s Centro de Investigaciones de la Economía Mundial (CIEM).

<sup>3</sup>For the detailed account of educational policy after 1959, see Nikolái Kolésnikov, 1983, *Cuba: Educación popular y preparación de los cuadros nacionales, 1959-1982* (Moscow: Editorial Progreso); most entries in the bibliography include commentaries on the literacy campaign of 1961. The most recent and thorough evaluation published in Cuba is that by Felipe de J. Pérez Cruz, 2001, *La alfabetización en Cuba: Lectura histórica para pensar el presente* (Havana: Editorial de Ciencias Sociales). For examples of the most analytical accounts available in the literature in English, see Richard Jolly, 1964, “The Literacy Campaign and Adult Education,” in *Cuba: The Economic and Social Revolution* (Chapel Hill: University of North Carolina Press); Jonathan Kozol, 1978, “A New Look at the Literacy Campaign in Cuba” *Harvard Educational Review* 48, 3(August): 341-77; and Karen Shaffer Vocke, 2001, “Literacy and Ideology in Cuba’s Special Period” (Toledo, OH: University of Toledo, Ph. D. dissertation).

<sup>4</sup>*Cuba: A Giant School* (Havana: Department of Information, Ministry of Foreign Affairs, 1965).

<sup>5</sup>Ernesto Guevara, 1968, *Venceremos: The Speeches and Writings of Che Guevara* (New York: Simon and Schuster), 391.

<sup>6</sup>Lowry Nelson, 1971, “The School Dropout Problem in Cuba,” *School and Society* 99(April): 234-35; and Julie M. Bunck, 1994, *Fidel Castro and the Quest for a Revolutionary Culture in Cuba* (University Park, PA: Pennsylvania State University Press).

<sup>7</sup>See Annex A.

<sup>8</sup>Most pertinent are Chapter V: Articles 39, 40; and Chapter VI: Article 43. See also Chapter I: Articles 5, 6; and Chapter IV: Articles 35, 38. <http://www.georgetown.edu/pdba/Constitutions/Cuba/cuba1992.html>.

<sup>9</sup>Mark Richmond, 1990, “The Cuban Educational Model and Its Influence in the Caribbean Region,” in *Education in Central America and the Caribbean*, eds. Colin Brock and Donald Clarkson (London: Routledge), 73-74.

<sup>10</sup>Richmond 1990, 74.

<sup>11</sup>*Granma* (6 March 1990).

<sup>12</sup>*Granma Weekly Review*(4 October 1990): 4.

<sup>13</sup>Jean-Pierre Beauvais, 1983, “Achievements and Contradictions of the Cuban Workers’ State,” in *Crisis in the Caribbean*, eds. Fitzroy Ambursley and Robin Cohen (New York: Monthly Review Press), 49.

<sup>14</sup>*Educación*, 1991, “Requerimientos básicos para el Período Especial en los centros docentes,” 21(June 1991): 23-26; and Oneida Álvarez Figueroa, 1997, “El sistema educativo cubano en los noventas,” *Papers: Revista Sociológica* 52: 115-37.

<sup>15</sup>*Ibid.* and Uriarte, 34-37. See also Annex B.

<sup>16</sup>Magali Estrada, 2000, "Alarmante éxodo de profesores de alto nivel," Buró de Prensa Independiente de Cuba (22 September). <http://www.bpicuba.org/otros/alarmante.htm>. On college students volunteering to substitute in schools, see "Ninguno de los actuales problemas," *Granma*. <http://www.granma.cubaweb.cu/temas11/articulo58.html>.

<sup>17</sup>During a study tour, Gasperini was informed that "new professional activities, especially in tourism and in foreign firms [have caused] teacher attrition of 4 to 8 percent in the eastern oriental provinces, where tourism is more developed." in Lavinia Gasparini, 2000, "The Cuban Education System: Lessons and Dilemmas," in *The Education Report and Management Publication Series*, vol. 5 (Washington: The World Bank), 7. The reader is advised that the more rural eastern provinces are less developed for tourism and offer less opportunities to access dollars. Most tourists to the island concentrate in the area of Havana and the beach strip east of Havana to Varadero. Consequently, the central and eastern regions offer less incentives to attract teachers.

<sup>18</sup>Ronald A. Lindahl, 2000, "Evaluating the Cuban System: A Goal-Fulfillment Critique," *International Education* 29:2 (Spring): 5-20.

<sup>19</sup>Robert C. Johnston, 2003, "Educators Worldwide Convene at Meeting in Cuba," *Education Week* 22:26 (12 March): 8.

<sup>20</sup>Pedagogía '99, 1999, *La educación en Cuba: Encuentro por la unidad de los educadores latinoamericanos* (Havana: Ministerio de Educación), 16.

<sup>21</sup>Gasperini 2000, 2.

<sup>22</sup>UNESCO, 1998, *Laboratorio latinoamericano de evaluación de la calidad de la educación, Primer estudio internacional comparativo sobre lenguaje, matemáticas, y factores asociados en tercero y cuarto grado* (Santiago de Chile: UNESCO).

<sup>23</sup>In 1997, sabbatical leave was granted to 11,313 teachers. In *Pedagogía '99, 1999*, 46-47.

<sup>24</sup>Karen Shaffer Vocke, 2001, "Literacy and Ideology in Cuba's Special Period," Toledo, OH: University of Toledo, Ph.D. dissertation. See also Christopher Worthman and Lourdes Kaplan, 2001, "Literacy Education and Dialogical Exchange: Impressions of Cuban Education in One Classroom," *Reading Teacher* 54:7 (April): 648-56.

<sup>25</sup>The Instituto Preuniversitario Vocacional de Ciencias Exactas Vladimir Ilich Lenin is the secondary institution of choice for the Cuban political elite to send their children, limiting the number of places for students who can be admitted via the entrance exam. Parents pay for tutoring months in advance of the examination date; some teachers run Saturday sessions in their homes, a way of supplementing their salaries privately. Testimonies of several interviewees. See also Jacques-Yves Cousteau, prod., 1986, *Cuba: Waters of Destiny*, (Atlanta: Turner Program Services), a documentary film with scenes at the Lenin School; the absence of Afro-Cubans (I counted two) is a blatant statement of class and color discrimination in accessing the best college preparatory school in Cuba.

<sup>26</sup>Vocke, 2001, 1. The study tour was undertaken by members of the Colombian government, the Cuban Ministry of Education and World Bank staff.

<sup>27</sup>Eusebio Mujal-León and Joshua W. Bushby, 2001, "Much Ado About Something?: Regime Change in Cuba," *Problems of Post-Communism* 48(November/December): 12-13.

<sup>28</sup>*Granma*, 2002, "En septiembre celebraremos una de las más grandes victorias en beneficio de nuestros maravillosos niños," 1 July. <http://granma.cu/documento/espanol02/044-e.htm>. See also Iraida Calzadilla Rodríguez, 2002, "Más allá de

la escuela bonita,” *Granma*, 21 February. <http://www.granma.cubaweb.cu/2002/02/21/nacional/articulo03.html#inicio>.

<sup>29</sup>*Granma*, 2002, “Fidel presides over graduation ceremony for first group of junior high school teachers,” 16 July. <http://granma.cu/ingles/julio02-3/29fidel-i.html>. A corresponding article in Spanish edition cannot be located.

<sup>30</sup>*Granma*, 2002, “El próximo septiembre será inolvidable por su trascendencia para la educación en Cuba,” 14 August. <http://granma.cu/espanol/agosto02/mie14/elproximo-e.html>.

<sup>31</sup>“El proximo septiembre...”

<sup>32</sup>María Julia Mayoral, 2002, “Fidel: un vistazo de madrugada a escuelas del Cerro,” *Granma* (11 July): 1.

<sup>33</sup>*Granma*, 2002, “Trabajo voluntario masivo cederista,” 8 October. <http://www.granma.cubaweb.cu/2002/08/10/nacional/articulo14.html>.

<sup>34</sup>“El próximo septiembre...”

<sup>35</sup>Reynold Rassi and Alberto Núñez, 2002, “Para este país no hay nada imposible: Presidió Fidel la Asamblea de Balance,” *Granma* (8 July): 1.

<sup>36</sup>The only commentary to the 8 July 2002 *Granma* article that I have seen is the one by independent journalist Adolfo Fernández Saíenz, “La nueva escuela,” Website, Havana, Cuba: Cuba Católica. <http://www.ecograficos.com/cubacatolica/articulo12.html>.

<sup>37</sup>Ángel Rodríguez, 2000, in *Tribuna de La Habana* (21 May), as quoted and analyzed by Julio Ramón Pita, 2000, “La contorsión familiar ante la escuela al campo,” *Espacios* 4 (3): 40-41.

<sup>38</sup>Researcher Denise Blum claims to have recognized how polemical the *escuela al campo* (EAC) were when she overheard women in their fifties attribute the lost of morality and family values to the EAC policy. In Denise Blum, 2003, “Cuba’s *Escuela al Campo* Program: Adapting to the 21<sup>st</sup> Century,” Latin American Studies Association Congress. Manuscript, p. 29. The remarks Blum quotes are consistent with the response of all those I interviewed. Various documents by dissidents or published in exile corroborate on the conditions of Cuban countryside summer schools. See data collected from interviewees in Frank de Varona and Arnhilda Badía, comps., 1993, *La educación en Cuba: Pasado, presente y futuro*. Comité de Estudios para la Reforma Educativa en Cuba (Miami: The Endowment for Cuban American Studies).

<sup>39</sup>I read the Denise Blum’s manuscript too late to adequately analyze it for this study. Her fieldwork, conducted while attending a *escuela al campo*, is perceptive and thought-provoking; reading recommended.

<sup>40</sup>Robert C. Johnston, 2003, “A Revolutionary Education,” *Education Week* 22:25 (5 March): 37.

<sup>41</sup>Ibid.

<sup>42</sup>Ibid. While past evidence leads me to the conclusion that it was no coincidence that the regional director of schools for the Ciénaga jurisdiction managed to contribute to the US article, Johnston was able to move freely in a taxi, along with photographer Allison Shelley. He was only supposed to visit schools for which he had been given a permit but some school principals allowed him in the school premises without the official pass. (Telephone conversation with author, 5 March 2003)

<sup>43</sup>*Trabajadores*, 2001, “Convocan al Congreso de los Educadores,” 31, 55 (December 24): 2.

<sup>44</sup>Most interviewees are quick to comment on the lack of respect for school property in Cuba. Ramón Colás has emphasized that the attitude that *nada pertenece a nadie* [nobody owns anything] is pervasive. Juan Navarrete, a former art teacher, was assigned to a School Construction Brigade, when he was dismissed from his teaching job upon filing papers to leave the country in 1983. He recalls that the “regulars” in the brigade were more of a gang that stole openly to resell the construction materials. From faucets to tiles, boarding students also took school property with them when going home on the weekends. While the prefabricated structures erected in the early 1970s were of poor quality, Navarrete felt that the state of dilapidation was not due as much to quality as to lack of care; he was part of the group that repaired former President Grau San Martín’s home only five years after it had become a school, and he said the place looked like a war zone. The former Brazilian embassy became a school in 1966; a website advertising it is now available for rent mentions that the mansion felt in disrepair and was closed, then refurbished for the tourist industry in 1997 for US\$3 million. ([www.habanarenta.com/mansiones/](http://www.habanarenta.com/mansiones/)). Miranda of the Colegio confirmed the reputation of the construction brigades. He believes the government has resorted to using regular factory workers, some of whom may have children in the school they are assigned to fix, as a way to minimize theft and damages.

<sup>45</sup>Reinaldo Cosano Alén, 2001, “Muitarán a escolares que dañen la edificación o el mobiliario de sus escuelas,” *Cubonet independiente* (7 August). <http://www.cubonet.org/search.html>.

<sup>46</sup>Roberto Larramendi, vice-president of the Colegio, pointed out that these schools are clearly associated by the general population with the repressive apparatus.

<sup>47</sup>“Fidel presides...”

<sup>48</sup>*Granma* (14 March 1969): 1.

<sup>49</sup>Rassi and Núñez 2002.

<sup>50</sup><http://www.cubonet.org/bibliotecas/proyecto.html> and [www.Bibliotecas-Independientes.org](http://www.Bibliotecas-Independientes.org).

<sup>51</sup>The Friends of Cuban Libraries, 2002, website, Long Island, NY: The Friends of Cuban Libraries. <http://www.friendsofcubanlibraries.org>.

<sup>52</sup>Reinaldo Arenas (1943-1990) was a beneficiary of the educational opportunities made available by the revolution in 1959 when, at age 16, he left rural Oriente and went to study in Havana. For details of his proscription, see his autobiography *Before Night Falls*.

<sup>53</sup>Enrico Mario Santí, 1986, “Martí and the Cuban Revolution,” *Cuban Studies* 16: 137-50.

<sup>54</sup>Graciella Cruz-Taura, 1989, “The Historiography of the Cuban War of 1868,” in *Proceedings of the American Historical Association 1989* (Ann Arbor: University Microfilms International).

<sup>55</sup>See Dagoberto Valdés Hernández, 1997, *Reconstruir la sociedad civil: Un proyecto de educación cívica, pluralismo y participación para Cuba* (Caracas: Fundación Konrad Adenauer).

<sup>56</sup>Mission statement: The Civic and Religious Center (CFCR by the Spanish initials) has the purposes of promoting men and women as free, responsible and sharing persons. It contributes to the rebuilding and strengthening of the Cuban civil society, thus making a most democratic future. The references for its inspiration are: Emmanuel Mounier’s personalism, the education in freedom of Paulo Freire, and think-training school of Félix Varela (the Father of Cuban Culture). The Civic and Religious Education Center (CREC) of the Pinar del Rio Diocese, 2002, Website. <http://www.vitral.org/>.

<sup>57</sup>CREC, 2002.

<sup>58</sup>*Vitral*, 1998, “La educación: El derecho a elegir cómo ser,” 5: 24(March-April).

<sup>59</sup>See among others: Julio Ramón Pita, 1999, “Educación e ideología,” *Espacios* 3,2: 36-37; \_\_\_\_\_, 2001, “La cuestión familia,” *Espacios* 5,3 : 30-32; and Joaquín Bello, 1999, “Seamos los protagonistas de nuestra historia,” *Espacios* 3,3:16-18.

<sup>60</sup>For profiles of Miranda, see section 5, profile 10, in Amnesty International, and Robert C. Johnston, 2003, “A Revolutionary Education,” *Education Week* 22:25 (5 March). See also Anna Rosa Veitía, 2003, “Ocuparon dibujos infantiles a pedagogo independiente,” *Buró de Prensa Independiente* (21 March). <http://www.cubanet.org/CNews/y03/mar03/21a3.htm>.

<sup>61</sup>Guevara 1968, 391-94.

<sup>62</sup>For example, see Justo A. Chávez Rodríguez, 1990, “La tradición pedagógica cubana. Primera parte,” *Educación* 20 (July-September): 25-36; and \_\_\_\_\_, 1996, *Bosquejo histórico de las ideas educativas en Cuba* (Havana: Editorial Pueblo y Educación).

<sup>63</sup>Source: Colegio de Pedagogos Independientes de Cuba, 2001, *Reflexiones* (November).

<sup>64</sup>See Lidia Turner Martí et al., 1996, *Martí y la educación*, (Havana: Editorial Pueblo y Educación); and Justo Luis Pereda Rodríguez, Montano Cortina, and Gil Ramos Blanco, 1989, “José Martí presente en el plan de perfeccionamiento,” *Educación* 19 (January-March): 78-87.

<sup>65</sup>For an official application of Martí’s thought to Cuban education, see Pareda et. al 1989; particularly the comments on page 81 equating Martí’s ideas to Marxism-Leninism. For analyses of the uses of Martí’s thought, see Ottmar Ette, 1995, *José Martí Apóstol, Poeta, Revolucionario: Una historia de su recepción* (Mexico: Universidad Nacional Autónoma de México); and Carlos Ripoll, 1984, *José Martí, the United States, and the Marxist Interpretation of Cuban History* (New Brunswick, CT: Transaction Books).

<sup>66</sup>Colegio de Pedagogos Independientes, 2001.

<sup>67</sup>Andy S. Gómez, 2003, “The Role of Education in Promoting Cuba’s Integration into the International Society: Lessons in Transition from the Post-Communist States in Central and Eastern Europe,” (Coral Gables, FL: Cuba Transition Project).

<sup>68</sup>To commemorate the centenary of the instauration of the Cuban Republic May 20, 2002, Martínez Núñez staged a play with the local children on the transfer of authority from the American occupation governor Leonard Wood to Cuba’s first president, Tomás Estrada Palma. The reader interested in the history of education in colonial Cuba should note that Bachiller y Morales published a three-volume annotated bibliography on this topic.

<sup>69</sup>For essays by Julio Antonio Mella, Raúl Roa, Blas Roca, Che Guevara, Carlos Rafael Rodríguez, Armando Hart, and Juan Maarinello, see Centro de Estudios Martianos, 1978, *Siete enfoques marxistas sobre José Martí* (Havana: Editora Política, Departamento de Orientación Revolucionaria del Comité Central del Partido Comunista de Cuba). For more information about the Centro de Estudios Martianos, see <http://www.filosofia.cu/cem/>.

<sup>70</sup>Félix Lizaso and Ernesto Ardura, 1954, *Personalidad e ideas de José Martí* (Havana: Úcar, García, S.A.), 68-69.

<sup>71</sup>I am grateful to Professor Antonio Jorge for his conversations with me on this topic. His reference to what American sociologist Robert Bellah has called “habits of the

heart” helps explain the survival of Martí’s ideas four decades after their distorted use by the Cuban government.

<sup>72</sup>Bunck, 1994.

<sup>73</sup>Bunck, 1994.

<sup>74</sup>Rassi and Núñez, 2002.

<sup>75</sup><http://www.cursoenlinea.cu/> and <http://www.EduToursToCuba.com>.

<sup>76</sup>See Gómez on the Czech experience. On Russia, see Mary Canning, Peter Moock, and Timothy Heleniak, 1999, *Reforming Education in the Regions of Russia* (Washington: The World Bank).

<sup>77</sup>Thomas E. Freeman, [n.d.], “Enseñanza pública: La burocratización de la mente,” published by Fundación Atlas para una Sociedad Libre. In <http://www.atlas.org.ar/educacion/lehman.asp>.

<sup>78</sup>For an excellent study of civil society developments outside a religious context, see Harold Dilla Alfonso, Armando Fernández Soriano, and Margarita Castro Flores, 1998, “Movimientos comunitarios en Cuba: Un análisis comparativo,” *Cuban Studies* 28: 100-24.

<sup>79</sup>Ricardo Mesa and Andrés Rodríguez, 1998, “Un grito por el desarrollo,” *Espacios* 2, 3: 22-24.

<sup>80</sup>“Cuba prepara Congreso ‘Cultura y Desarrollo,’” 2003, *La Prensa* [de Panamá]. <http://www.prensa.com/hoy/revista/1048176.html>

<sup>81</sup>Pedagogía’99, 1999, 66-67. Opened in 1998, Cuba began the Escuela Latinoamericana de Ciencias Médicas, which expects to graduate 10,000 foreign physicians after a 6.5-year program. By 2002, 5, 853 students from 24 countries were enrolled including some from the United States; in José A. de la Osa, 2002, “5853 estudiantes en sus aulas,” *Granma* (3 December). <http://www.granma.cubaweb.cu/2002/03/12/nacional/articulo04.html>.

<sup>82</sup>This recommendation is also the main premise of Frank de Varona and Arnhilda Badía, comps. 1993, *La educación en Cuba: Pasado, presente y futuro*. Comité de Estudios para la Reforma Educacional en Cuba. (Miami: The Endowment for Cuban American Studies), 147-159.

<sup>83</sup>The literature on civics and American education is extensive; recent useful works include R. Freeman Butts, 1989, *The Civic Mission in Educational Reform: Perspectives for the Public and the Profession* (Stanford, CT: Hoover Institution Press); and Henry Milner, 2002, *Civic Literacy: How Informed Citizens Make Democracy Work* (Hanover, CT: University Press of New England). Websites in the for US-sponsored National Endowment for Democracy, Department of Education, the Center for Democracy and Governance of the Agency for International Development, and the National Democratic Institute for International Affairs provide assistance for programs on civic education.

<sup>84</sup>Jorge Luis Romeu, 1998, “A Project for Faculty Development in a Transitional Cuba,” *Papers and Proceedings of the 8<sup>th</sup> Annual Meeting of the Association for the Study of the Cuban Economy (ASCE)*. 8: 134-41; and “Un proyecto para la formación de profesionales internacionales para una Cuba en transición,” 1999, *Papers and Proceedings of the 9<sup>th</sup> Annual Meeting of the Association for the Study of the Cuban Economy (ASCE)*. 9: 73-78; both articles in <http://lanic.utexas.edu/la/cb/cuba/asce/>.

## BIBLIOGRAPHY

- Aguirre, Benigno E., and Roberto J. Vichot. 1998. "The Reliability of Cuba's Educational Statistics." *Comparative Education Review* 42: 2(May): 118-38.
- Almendros, Herminio. 1985. *La escuela moderna: ¿reacción o progreso?* Havana: Editorial de Ciencias Sociales.
- \_\_\_\_\_. 1990. *Ideario pedagógico*. Havana: Editorial Pueblo y Educación.
- Almendros, Néstor. 1986. *Cuba: Pedagogía y sectarismo*. Madrid: Playor.
- Álvarez Figueroa, Oneida. 1997. "El sistema educativo cubano en los noventa." *Papers: Revista Sociológica* 52: 115-37.
- Amnesty International. 2003. "Cuba 'Essential Measures'? Human rights crack-down in the name of security." <http://web.amnesty.org/library/Index/ENGAMR250172003>.
- Arbesú, María Isabel. 1993. *La educación en Cuba: Un estudio histórico del sistema educativo cubano posrevolucionario*. Mexico, D.F.: Universidad Autónoma Metropolitana-Xochimilco.
- Ares, Guillermina. 2000. *Alfabetización: Historia y testimonios*. Havana: Editora Política.
- Arés Muzio, Patricia. 1998. "Familia, ética, y valores en la realidad cubana actual." *Temas* 15 (July-September).
- Bachiller y Morales, Antonio. 1859-1861. *Apuntes para la historia de las letras y de la instrucción pública en la isla de Cuba*. 3 vols. Havana: Impr. de P. Massana & Impr. del Tiempo.
- Baloyra, Enrique A. 2001. "Political Control and Cuban Youth." In *Cuban Communism*, eds., Irving L. Horowitz and Jaime Suchlicki. New Brunswick, CT: Transaction Publishers.
- Beauvais, Jean-Pierre. 1983. "Achievements and Contradictions of the Cuban Workers' State." In *Crisis in the Caribbean*, eds., Fitzroy Ambursley and Robin Cohen. New York: Monthly Review Press.
- Bell Rodríguez, Rafael. 1997. *Educación especial: Razones, visión actual y desafíos*. Havana: Editorial Pueblo y Educación.
- Bello, Joaquín. 1999. "Seamos protagonistas de nuestra historia." *Espacios* 3, 3: 16-18.
- Berube, Maurice R. 1984. *Education and Poverty: Effective Schooling in the United States and Cuba*. Westport, CT: Greenwood Press.
- <http://www.Bibliotecas-Independientes.org>.
- Blanco Caballería, Paulina. 1990. "Una enseñanza del marxismo-leninismo vinculada a las particularidades de la construcción del socialismo en Cuba." *Educación* 20: (April-June): 68-75.

- Blum, Denise. 2003. "Cuba's *Escuela al Campo* Program: Adapting to the 21<sup>st</sup> Century." Latin American Studies Association Congress. Manuscript.
- Bowles, Samuel. 1971. "Cuban Education and the Revolutionary Ideology." *Harvard Educational Review* 41, 4: 472-500.
- Buenavilla Recio, Rolando et al. 1995. *Historia de la pedagogía en Cuba*. Havana: Editorial Pueblo y Educación.
- Bunck, Julie M. 1994. *Fidel Castro and the Quest for a Revolutionary Culture in Cuba*. University Park, PA: Pennsylvania State University Press.
- Butts, R. Freeman. 1989. *The Civic Mission in Educational Reform: Perspectives for the Public and the Profession*. Stanford, CT: Hoover Institution Press.
- Calzadilla Rodríguez, Iraida. 2002. "Más allá de la escuela bonita." *Granma*, February 21.  
<http://www.granma.cubaweb.cu/2002/02/21/nacional/articulo03.html#inicio>.
- Cánovas Fabelo, Lesbia and José Zilberstein Toruncha. 1999. *La investigación educativa en Cuba y la calidad educativa a las puertas del siglo XXI: Restos y perspectivas*. Havana: Ministerio de Educación.
- Carnoy, Martin. 1999. *Globalization and Educational Reform: What Planners Need to Know*. Paris: UNESCO International Institute for Educational Planning.
- \_\_\_\_\_. 1990. "Socialist Development and Educational Reform in Cuba 1959-1980." In Bill Nasson and John Samuel, eds. *Education from Poverty to Liberty*. South Africa: Creda Press.
- \_\_\_\_\_. et al. 1990. *Education and Social Transition in the Third World*. Princeton: Princeton University Press.
- Camper, Natalie K. 1979. "Cuba's Post-Revolutionary Work-Study Education: 1959-1975: History, Ideology and Implementation." Boston: Boston College, Ph. D. dissertation.
- Canning, Mary, Peter Moock, and Timothy Heleniak. 1999. *Reforming Education in the Regions of Russia*. Washington: The World Bank.
- Cartaya Cotta, Perla A. and José A. Joanes Pando. 1996. *Raíces de la escuela primaria cubana, 1902-1925*. Havana: Editorial Pueblo y Educación.
- Castillo Suárez, Silvia. 1989. "Las relaciones del maestro con los padres." *Educación* 19 (January-March): 20-24.
- Castro, Fidel. 1990. "Fidel en la clausura de Pedagogía '90." *Educación* 20: (April-June): 3-26.
- \_\_\_\_\_. 1974. *La educación en revolución*. Havana: Instituto Cubano del Libro, 1974.
- \_\_\_\_\_. 1992. *Luchadores por la calidad de la educación*. Havana: Editora Política, 1992.
- \_\_\_\_\_. 2002. "El próximo septiembre será inolvidable por su trascendencia para la educación en Cuba." *Granma*, August 14. <http://granma.cu/espanol/agosto02/mie14/elproximo-e.html>.



- Centro de Estudios Martianos. 1978. *Siete enfoques marxistas sobre José Martí*. Havana: Editora Política, Departamento de Orientación Revolucionaria del Comité Central del Partido Comunista de Cuba.
- Cerezal Mezquita, Julio, Jorge Fiallo Rodríguez, and María del Rosario Patiño Rodríguez. 2000. *La formación liberal de los alumnos en los umbrales del siglo XXI*. Havana: Editorial Pueblo y Educación.
- Chávez Rodríguez, Justo A. 1990. "La tradición pedagógica cubana. Primera parte." *Educación* 20 (July-September): 25-36.
- \_\_\_\_\_. 1992. *Del ideario pedagógico de José de la Luz y Caballero (1800-1862)*. Havana: Editorial Pueblo y Educación.
- \_\_\_\_\_. 1996. *Bosquejo histórico de las ideas educativas en Cuba*. Havana: Editorial Pueblo y Educación.
- The Civic and Religious Education Center (CREC) of the Pinar del Rio Diocese. 2002. Website. <http://www.vitral.org/>.
- Colás Castillo, Ramón. 2002. "Niveles de dependencia del cubano." Manuscript.
- Colegio de Pedagogos Independientes de Cuba. 2001. *Reflexiones*. Havana: Colegio de Pedagogos Independientes de Cuba.
- Colegio de Pedagogos Independientes de Cuba. 1999. "Declaración de Principios del Colegio de Pedagogos de Cuba." (13 June). <http://www.bpi.cuba.org/cultura.declara.htm>.
- El comunismo en Cuba: La destrucción de las organizaciones magisteriales*. No. 22. 1966. Miami: Ediciones del Directorio Magisterial Cubano en el Exilio.
- Concheso Fernández, Aurelio. 1956. *El problema educacional cubano: fundamentos y urgencias de una reforma*. Havana: Ediciones del Instituto Cívico Militar.
- "Convocan al Congreso de los educadores." *Trabajadores* 31:55(24 December 2001): 2.
- Corrales, Javier. 1999. *The Politics of Education Reform: Bolstering the Supply and Demand, Overcoming Institutional Blocks*. The Education Reform and Management Publication Series. 2 (1). Washington, D.C.: The World Bank.
- Cosano Alén, Reinaldo. 2001. "Multarán a escolares que dañen la edificación o el mobiliario de sus escuelas." *Cubonet independiente*, 7 August. <http://www.cubonet.org/search.html>.
- Cousteau, Jacques-Yves, producer. 1986. *Cuba, Waters of Destiny*. Documentary film. Atlanta: Turner Program Services.
- Cruz-Taura, Graciella. 2002. "Rehabilitando la educación en la Cuba que transita." *Cuba in Transition*. Washington: Association for the Study of the Cuban Economy (ASCE). Vol. 12: 94-100. <http://lanic.utexas.edu/la/cb/cuba/asce/>.
- \_\_\_\_\_. 1989. "The Historiography of the War of 1868." *Proceedings of American Historical Association 1989*. Ann Arbor: University Microfilms International.
- Cruzada Educativa Cubana: Doce años de trabajos por Cuba y la rehabilitación*

- de su escuela cristiana y democrática, 1862-1974*. 1974. Miami: Cruzada Educativa Cubana.
- Cuba: A Giant School* [Pamphlet]. 1965. Havana: Department of Information, Ministry of Foreign Affairs.
- Cuba, organización de la educación, 1983-1985*. 1986. XL Conferencia Internacional de la Educación, OIE. Havana: Ministerio de la Educación.
- “Cuba prepara Congreso ‘Cultura y Desarrollo.’” 2003. *La Prensa* [de Panamá]. <http://www.prensa.com/hoy/revista/1048176.html>.  
<http://www.cubanet.org/bibliotecas/proyecto.html>.  
<http://www.cursoenlinea.cu/>.
- Departamento de Marxismo-leninismo del IPE Nacional. 1990. “Dialéctica de la Educación Cívica.” *Educación* 20(January-March): 100-103.
- Díaz-Briquets, Sergio. 1993. “Collision Course: Labor Force and Educational Trends in Cuba.” *Cuban Studies* 23: 91-112.
- Díaz Pendas, Horacio. 1990. “Aprendiendo historia en el museo: ¿A qué historia aspiramos?” *Educación* 20(April-June): 76-86.
- Dilla Alfonso, Harold *et al.* 1993. *Participación y desarrollo en los municipios cubanos*. Havana: Editora Política.
- Dilla Alfonso, Harold, Armando Fernández Soriano, and Margarita Castro Flores. 1998. “Movimientos comunitarios en Cuba: Un análisis comparativo.” *Cuban Studies* 28: 100-24.
- Donoghue, Eileen F., and Bruce R. Vogeli. 1998. “Cuba’s Schools for the Mathematically and Scientifically Talented.” *Gifted Child Today Magazine* 21: 3 (May-June): 32-35.
- Duarte, Lucio. 1998. “Acosan a disidente que aboga por derecho de los padres a escoger la educación de sus hijos.” *Buró de Prensa Independiente de Cuba* (28 November). <http://www.bpicuba.org/denuncias/acosan.htm>.
- Eckstein, Susan. 1997. “The Coming Crisis in Cuban Education.” *Assessment in Education* 4 (January): 107-20.
- Eisner, Elliot W. 1991. “Taking a Second Look: Educational Connoisseurship Revisited.” In *Evaluation and Education: At Quarter Century*, eds., Milbrey W. McLaughlin and D.C. Phillips. Chicago: University of Chicago Press.
- IX Encuentro de investigadores e innovadores de la educación [Havana, 1999]*. 2000. Bogotá: Convenio Andrés Bello.
- Espina Pérez, Darío. 1993. *Sugerencias sobre la reconstrucción de Cuba*. Santo Domingo: Editora Corripio, C. por A.
- Espinosa, Rolando. 1999. *Ideas para la reconstrucción de la Isla liberada*. Miami: Editorial Lincoln-Martí.
- Estrada, Magali. 2002. “Alarmante éxodo de profesores de alto nivel.” *Buró de Prensa Independiente de Cuba* (22 September). <http://www.bpicuba.org/otros/alarmante.htm>.

- Ette, Ottmar. 1995. *José Martí Apóstol, Poeta, Revolucionario: Una historia de su recepción*. Mexico, D.F.: Universidad Nacional Autónoma de México.
- Fauth, Gloria, and Bonnie Daniels. 2001. *Impact Evaluation [of] Youth Reintegration Training and Education for Peace (YRTEP) Program*. Washington, D.C.: USAID Office of Transition Initiatives.
- Fernández, Damián J. 2000. *Cuba and the Politics of Passion*. Austin: University of Texas Press.
- \_\_\_\_\_. 2001. "Society, Civil Society, and the State: An Uneasy Three-Way Affair." *Problems of Post-Communism* 48 (November/December): 56-63.
- Fernández Saíenz, Adolfo. "La nueva escuela." Website. Havana, Cuba: Cuba Católica. <http://www.ecograficos.com/cubacatolica/articulo12.html>.
- Fitzgerald, Frank T. 1994. *The Cuban Revolution in Crisis: From Managing Socialism to Managing Survival*. New York: Monthly Review Press.
- Freeman, Thomas E. "Enseñanza pública: La burocratización de la mente." Published by Fundación Atlas para una Sociedad Libre. <http://www.atlas.org.ar/educacion/lehman.asp>.
- The Friends of Cuban Libraries. 2002. Website. Long Island, NY: The Friends of Cuban Libraries. <http://www.friendsofcubanlibraries.org>.
- García Galló, Gaspar Jorge. 1974. "Bosquejo general del desarrollo de la educación en Cuba." *Educación* 14 (July-September): 7-58.
- García Ramis, Lisardo et al. 1996. *Los retos del cambio educativo*. Havana: Editorial Pueblo y Educación.
- Gasperini, Lavinia. 2000. *The Cuban Education System: Lessons and Dilemmas*. The Education Reform and Management Publication Series. Vol. 1, no. 5. Washington: The World Bank.
- Gerrard, Lesley. 1994. "The Collapse of Castro's Cornerstone." *The Times Educational Supplement* no. 4080 (September 9): 15.
- González, José R. 2000. "Ultrajan derechos de un niño en escuela primaria capitalina." Buró de Prensa Independiente de Cuba (December 30). <http://www.bpcuba.org/denuncias/ultrajan.htm>.
- González, María de los Ángeles. 2000. "Celebran en La Habana Primer Taller de Pedagogos Independientes." Buró de Prensa Independiente de Cuba (September 20). <http://www.bpcuba.org/cultura/pedagogos.htm>.
- González, Reynaldo. 1999. "Se agudiza el déficit de profesores en Provincia de Pinar del Río." Buró de Prensa Independiente de Cuba (December 21). [http://www.bpicuba.org/otros/agu\\_prof.htm](http://www.bpicuba.org/otros/agu_prof.htm).
- González Corona, Jorge. 1994. "Algunas consideraciones sobre la planificación del desarrollo de la educación en Cuba." *Revista Cubana de Educación Superior* 14: 1.
- Granma. 2002. "En septiembre celebraremos una de las más grandes victorias en

- beneficio de nuestros maravillosos niños.” July 1. <http://granma.cu/documento/espanol02/044-e.htm>.
- Granma. 2002. “Fidel presides over graduation ceremony for first group of junior high school teachers.” July 16. [English edition]
- Granma. 2002. “Trabajo voluntario masivo cederista.” October 8. <http://www.granma.cubaweb.cu/2002/08/10/nacional/articulo14.html>.
- Guerra y Sánchez, Ramiro. 1952. *Martí en las primeras décadas de la escuela primaria republicana*. Havana: Imprenta “El Siglo XX”.
- Guerra y Sánchez, Ramiro. 1954. *Rehabilitación de la escuela pública, un problema vital de Cuba en 1954*. Havana: Imprenta P. Fernández.
- Guevara, Ernesto. 1968. *Venceremos: The Speeches and Writings of Che Guevara*, ed., John Gerassi. New York: Simon and Schuster.
- Hardin, Henry N. 1967. *Evaluating Cuban Education*. Coral Gables, FL: University of Miami School of Education.
- “Indicaciones generales del Ministro de Educación para el desarrollo del trabajo educativo y administrativo durante el año escolar 1989-90.” 1989. *Educación* 19 (January-March): 114-28.
- Jiménez, Georgina. 1985. *Hablemos de educación: recopilación de artículos, comentarios y reportajes sobre educación*. Havana: Editorial Pueblo y Educación.
- \_\_\_\_\_. 1991. “Precisan las prioridades en educación.” *Granma* 27: 69 (26 March): 2.
- Jolly, Richard. 1964. “The Literacy Campaign and Adult Education.” In *Cuba: The Economic and Social Revolution*. Dudley Seers, ed. Chapel Hill, NC: University of North Carolina Press.
- Johnston, Robert C. 2003. “A Revolutionary Education.” *Education Week* 22:25 (5 March): 34-41. <http://www.edweek.org/ew/ewstory.cfm?slug=25cuba.hh22>
- \_\_\_\_\_. 2003. “Educators Worldwide Convene at Meeting in Cuba.” *Education Week* 22:26 (12 March): 8. <http://www.edweek.org/ew/ewstory.cfm?slug=26cuba.hh22>
- \_\_\_\_\_. 2003. “Cuban Dissidents Arrested in Government Crackdown.” *Education Week* 22:28 (27 March); web page only. <http://www.edweek.org/ew/ewstory.cfm?slug=28cuba.hh22> .
- Kolésnikov, Nikolái. 1983. *Cuba: Educación popular y preparación de los cuadros nacionales, 1959-1982*. Moscow: Editorial Progreso.
- Kozol, Jonathan. 1978. “A New Look at the Literacy Campaign in Cuba.” *Harvard Educational Review* 48:3 (August): 341-77.
- La Belle, Thomas J., and Christopher R. Ward. 1990. “Education Reform When Nations Undergo Radical Political and Social Transformations.” *Comparative Education* 26: 1: 95-106.
- Laboratorio Latinoamericano de Evaluación de la Calidad de la Educación. 1998. *Primer estudio internacional comparativo sobre lenguaje, matemáticas y factores*

*asociados en tercero y cuarto grados*. Santiago de Chile: UNESCO.

Leiner, Marvin. 1985. "Cuban Schools: 25 Years Later." In *Cuba: Twenty-five Years of Revolution, 1959-1984*, eds. S. Halebsky and John M. Kirk. New York: Praeger Publishers.

Leiner, Marvin. 1981. "Two Decades of Educational Change in Cuba." *Journal of Reading* 25: 3 (December).

Lindahl, Ronald A. 2000. "Evaluating the Cuban Education System: A Goal-Fulfillment Critique." *International Education* 29: 2 (Spring): 5-20.

Lindahl, Ronald A. 1998. "Reflections on Educational Reform in Cuba." *International Journal of Educational Reform* 7: 4 (October): 300-08.

Lizaso, Félix, and Ernesto Ardura. 1954. *Personalidad e ideas de José Martí*. Havana: Úcar, García, S.A..

López Hurtado et al. 1996. *El carácter científico de la pedagogía en Cuba*. Havana: Editorial Pueblo y Educación.

Lorenzetto, Anna, and Karel Neys. 1965. *Informe sobre los métodos y los medios utilizados en Cuba para eliminar el analfabetismo, elaborado para la UNESCO*. Havana: Cuban National Commission for UNESCO.

Lotti, Alina M. 2001. "Educación en Cuba: Una obra sin precedente. La historia nos asombra." *Trabajadores* 31:55 (24 December): 2.

Loyd, Marion. 2001. "Independent Libraries in Cuba Defy Government's Lock on Information." *The Chronicle of Higher Education* 47:39 (8 June): A40-A42.

\_\_\_\_\_. 2001. "Distance Education Plays Unusual Role in Cuba's Literate but Desolate Society." *The Chronicle of Higher Education* 47:40 (15 June): A31.

Lutjens, Sheryl L. 1996. *The State, Bureaucracy, and the Cuban Schools: Power and Participation*. Boulder: Westview Press.

\_\_\_\_\_. 1998. "Education and the Cuban Revolution: A Selected Bibliography." *Comparative Education Review* 42: 2 (May): 197-224.

\_\_\_\_\_. 2000. "Restructuring Childhood in Cuba: The State as Family." In Roslyn Arlin Mickelson, ed. *Children on the Streets of the Americas: Homelessness, Education and Globalization in the United States, Brazil and Cuba*. New York: Routledge.

MacDonald, Theodore. 1985. *Making a New People*. Vancouver: New Star Books, Ltd.

Martínez Núñez, Juan Carlos, and Lourdes Cecilia Gómez Gómez. 2001. *Rehabilitación de la educación cubana: Diez pasos del sumario*. Bayamo, Cuba: Colegio de Pedagogos Independientes de Cuba.

Mayo, Marjorie. 1997. *Imagining Tomorrow: Adult Education for Transformation*. Leicester, England: National Institute of Adult Continuing Education.

Mayoral, María Julia. 2002. "Fidel: un vistazo de madrugada a escuelas del Cerro," *Granma*. 11 July.

McDonald, Jane A. 2000. "Forty Years after the Revolution: A Look at Education

- Reform in Cuba.” *International Journal of Educational Reform* 9:1 (January): 44-49.
- Mehrotra, Santosh. 2000. *Integrating Economic and Social Policy: Good Practices from High-Achieving Countries*. Florence: UNICEF Innocenti Research Centre.
- Mesa, Ricardo, and Andrés Rodríguez. 1998. “Un grito por el desarrollo.” *Espacios* 2, 3: 22-24.
- Mesa-Lago, Carmelo, ed. 1971. *Revolutionary Change in Cuba*. Pittsburgh: University of Pittsburgh Press.
- \_\_\_\_\_. 2000. “The Resurrection of Cuban Statistics.” *Cuban Studies* 31: 139-50.
- Miller, Mark M. *et al.* 1996. “Cuban Geography in Higher Education: Survival in the ‘Special Period.’” *Journal of Geography* 95: 2 (March-April): 59-65.
- Milner, Henry. 2002. *Civic Literacy: How Informed Citizens Make Democracy Work*. Hanover: University Press of New England.
- Moura Castro, Claudio de. 1999. *Ugly Schools, Good Schools?* Education Unit, Sustainable Development Department. Washington: Interamerican Development Bank.
- Mújal-León, Eusebio. 2001. “Higher Education and the Institutionalized Regime.” In Irving L. Horowitz and Jaime Suchlicki, eds., *Cuban Communism*. 10<sup>th</sup> Edition. New Brunswick: Transaction Publishers.
- \_\_\_\_\_ and Joshua W. Bushby. 2001. “Much Ado About Something?: Regime Change in Cuba,” *Problems of Post-Communism* 48(November-December): 6-18.
- Mursulí García, Alina María. 1991. “La familia como núcleo de la sociedad.” *Educación* 21(June): 6-10.
- Nelson, Lowry. 1971. “The School Dropout Problem in Cuba.” *School and Society* 99(April): 234-35.
- Núñez Aragón, Elsa. 1989. “Las escuelas de educación familiar: Búsqueda de nuevas vías para el trabajo con la familia.” *Educación* 19(October-December): 20-24.
- Núñez Jover, Jorge, Manuel Medina, and José A. López Cerezo. 1999. “Graduate Programs in Science, Technology, and Society in Cuba: Relevant Characteristics.” *Science, Technology & Society* 119(Spring): 1-6.
- Oberg, Larry R. 1984. *Human Services in Postrevolutionary Cuba: An Annotated Bibliography*. Westport: Greenwood Press.
- Organización de Estados Iberoamericanos para la Educación, la Ciencia y la Cultura. 1984. *La educación en Cuba*. Co-edited by Cuba’s Ministry of Education. Havana: Combinado Poligráfico Alfredo López.
- Osa, José A. de la. 2002. “5853 estudiantes en sus aulas,” *Granma*, 3 December. <http://www.granma.cubaweb.cu/2002/03/12/nacional/articulo04.html>.
- Paulston, Rolland G. 1989. *Higher Education and the State in Cuba*. Pittsburgh:

University of Pittsburgh Press.

Pedagogía '99. 1999. *La educación en Cuba: Encuentro por la unidad de los educadores latinoamericanos*. Havana: Ministerio de Educación.

Pereda Rodríguez, Justo Luis, Leopoldo Montano Cortina, and Gil Ramos Blanco. 1989. "José Martí presente en el plan de perfeccionamiento." *Educación* 19(January-March): 78-87.

Pérez Cruz, Felipe de J. 2001. *La alfabetización en Cuba: Lectura histórica para pensar el presente*. Havana: Editorial de Ciencias Sociales.

Pita, Julio Ramón. 1999. "Educación e ideología." *Espacios* 3:2: 36-37.

\_\_\_\_\_. 2000. "La contorsión familiar en la escuela al campo." *Espacios* 4:3: 40-41.

\_\_\_\_\_. 2001. "La cuestión familia." *Espacios* 5:3: 30-32.

Ramos, Marcos Antonio. 2002. "Introduction." In *Problems of the New Cuba*. Miami: Editorial Cubana.

Rassi, Reynold and Alberto Núñez. 2002. "Para este país no hay nada imposible: Presidió Fidel la Asamblea de Balance..." *Granma* (8 July):1.

República de Cuba. 2001. *Anuario Estadístico de Cuba 2000*. Havana: Oficina Nacional de Estadísticas.

"Requerimientos básicos para el Período Especial en los centros docentes." 1991. *Educación* 21(June): 23-26.

Richmond, Mark. 1985. "Education and Revolution in Socialist Cuba: The Promise of Democratisation." In Colin Brock and Hugh Lawlor, eds., *Education in Latin America*. London: Croom Helm.

\_\_\_\_\_. 1990. "The Cuban Educational Model and Its Influence in the Caribbean Region." In Colin Brock and Donald Clarkson, eds., *Education in Central America and the Caribbean*. London: Routledge.

\_\_\_\_\_. 1990. "Revolution, Reform and Constant Improvement: 30 Years of Educational Change in Cuba," *Compare* 20: 2: 101-114.

Ripoll, Carlos. 1984. *José Martí, the United States, and the Marxist Interpretation of Cuban History*. New Brunswick: Transaction Books.

Romeu, Jorge Luis. 1998. "A Project for Faculty Development in a Transitional Cuba." *Papers and Proceedings of the 8<sup>th</sup> Annual Meeting of the Association for the Study of the Cuban Economy (ASCE)*. Vol. 8: 134-41. <http://lanic.utexas.edu/la/cb/cuba/asce/>.

\_\_\_\_\_. 1999. "Un proyecto para la formación de profesionales internacionales para una Cuba en transición." *Papers and Proceedings of the 12<sup>th</sup> Annual Meeting of the Association for the Study of the Cuban Economy (ASCE)*. Vol. 9: 73-78. <http://lanic.utexas.edu/la/cb/cuba/asce/>.

Roque, Jacinto. 2000. "Realizan primeros talleres pedagógicos independientes." Buró de Prensa Independiente de Cuba (9 September). <http://www.bpicuba.org/otros/talleres.htm>.

- \_\_\_\_\_. 2000. "Conmovedora denuncia de un ministro evangélico." Buró de Prensa Independiente de Cuba (4 April). <http://www.bpicuba.org/denuncias/evangelico.htm>.
- Santí, Enrico. 1986. "Martí and the Cuban Revolution." *Cuban Studies* 16: 137-50.
- Singh, Madhu. 1998. *School Enterprise: Combining Vocational Learning with Production. International Project on Technical and Vocational Education (UNESCO)*. Berlin: UNESCO.
- Sosa Rodríguez, Enrique and Alejandrina Penabaz Félix. 2001. *Historia de la educación en Cuba*. 3 vols. 2<sup>nd</sup> ed. Havana: Ediciones Boloña.
- Sotolongo, Nancy. 1999. "Declaración de Principios del Colegio de Pedagogos Independientes de Cuba." Buró de Prensa Independiente de Cuba (13 June). <http://www.bpicuba.org/cultura/declara.htm>.
- \_\_\_\_\_. 1998. "Crimen y corrupción en escuelas cubanas." Buró de Prensa Independiente de Cuba (27 November). <http://www.bpicuba.org/otros/crimen.htm>.
- \_\_\_\_\_. [n.d.]. "Traza sus objetivos el Colegio de Pedagogos Independientes de Cuba." Buró de Prensa Independiente de Cuba. <http://www.bpicuba.org/cultura/traza.htm>.
- \_\_\_\_\_. 1998. "Evidente racismo en Cuba." Buró de Prensa Independiente de Cuba (28 November). <http://www.bpicuba.org/denuncias/evidente.htm>.
- Trujillo Pis, Héctor. 1998. "Incremento de la ofensiva ideológica en el sector educacional." Buró de Prensa Independiente de Cuba (19 November). <http://www.bpicuba.org/ar-denuncias/sector.htm>.
- Turner Martí, Lidia et al. 1996. *Martí y la educación*. Havana: Editorial Pueblo y Educación.
- \_\_\_\_\_. 1999. *Del pensamiento pedagógico de Ernesto Che Guevara*. Havana: Editorial Capitán San Luis.
- United Nations. 2001. *Human Development Report*. <http://www.undp.org/hdr2001/back.pdf>.
- \_\_\_\_\_. 2002. *Report of the Secretary-General* 0249898-260802-251002, A/57/150. Fifty-seventh session. Paragraphs 3-7 of agency report.
- UNESCO Laboratorio latinoamericano de evaluación de la calidad de la educación. 1998. *Primer estudio internacional comparativo sobre lenguaje, matemáticas, y factores asociados en tercero y cuarto grado*. Santiago de Chile: UNESCO.
- Uriarte, Miren. 2002. *Cuba Social Policy at the Crossroads: Maintaining Priorities, Transforming Practice*. Boston: Oxfam America.
- Valdés Hernández, Dagoberto. 1997. *Reconstruir la sociedad civil: Un proyecto de educación cívica, pluralismo, y participación para Cuba*. Introduction by Nazario Vivero. Caracas: Fundación Conrad Adenauer.



- Valdés Veloz, Héctor and Francisco Pérez Álvarez. 1999. *Calidad de la educación básica y su evaluación*. Havana: Editorial Pueblo y Educación.
- Varona, Frank de. 1999. "Social Studies in a Democratic Cuba." Manuscript. 4 November.
- \_\_\_\_\_ and Arnhilda Badía, comps. 1993. *La educación en Cuba: Pasado, presente y futuro*. Comité de Estudios para la Reforma Educacional en Cuba. Miami: The Endowment for Cuban American Studies.
- Vecino Alegret, Fernando. 1996. *Algunas tendencias en el desarrollo de la educación superior en Cuba*. Havana: Editorial Pueblo y Educación.
- Veitía, Anna Rosa. 2003. "Ocuparon dibujos infantiles a pedagogo independiente." Buró de Prensa Independiente de Cuba (21 March). <http://www.cubanet.org/Cnews/y03/mar03/21a3.htm>.
- Vitral. 1998. "La educación: El derecho a elegir cómo ser," 5: 24(March-April). <http://www.vitral.org/>.
- Vocke, Karen Shaffer. 2001. "Literacy and Ideology in Cuba's Special Period." Ph.D. diss. University of Toledo.
- Wald, Karen. 1978. *Children of Che: Childcare and Education in Cuba*. Palo Alto: Ramparts Press.
- [The World Bank]. 2001. Draft to Guide for developing the education policy component of a Poverty Reduction Strategy Paper (PRSP). Washington, D.C.: The World Bank.
- Worthman, Christopher and Lourdes Kaplan. 2001. "Literacy Education and Dialogical Exchange: Impressions of Cuban Education in One Classroom." *Reading Teacher* 54:7 (April): 648-56.

## **Annex A: Ministerio de Educación**

*Source:* Kolésnikov, Nikolái. 1983. *Cuba: Educación popular y preparación de los cuadros nacionales, 1959-1982.* Moscow: Editorial Progreso.

# MINISTERIO DE EDUCACION

Nueva Estructura del Sistema Nacional de Educación Vigente con el Plan de Perfeccionamiento del Sistema a Partir del Curso Escolar 1977-78 \*)

## I. EDUCACION REGULAR

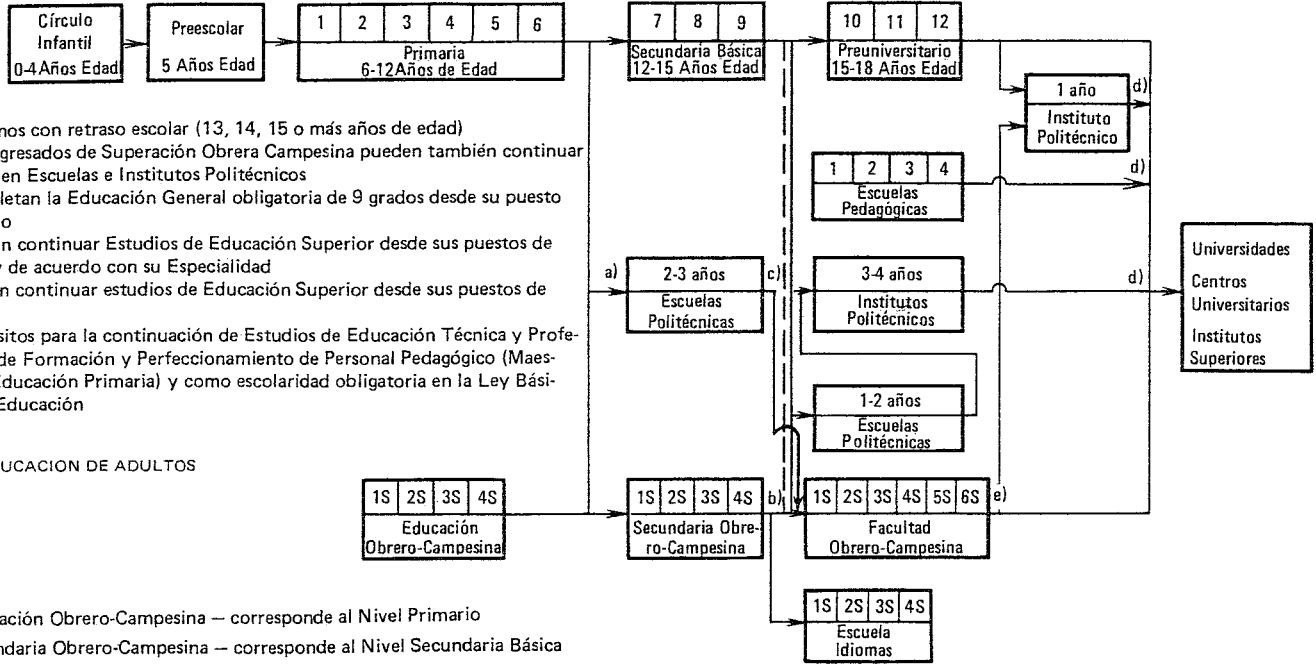

- a) Alumnos con retraso escolar (13, 14, 15 o más años de edad)
- b) Los Egresados de Superación Obrera Campesina pueden también continuar estudios en Escuelas e Institutos Politécnicos
- c) Completan la Educación General obligatoria de 9 grados desde su puesto de trabajo
- d) Pueden continuar Estudios de Educación Superior desde sus puestos de trabajo y de acuerdo con su Especialidad
- e) Pueden continuar estudios de Educación Superior desde sus puestos de trabajo

--Requisitos para la continuación de Estudios de Educación Técnica y Profesional y de Formación y Perfeccionamiento de Personal Pedagógico (Maestros de Educación Primaria) y como escolaridad obligatoria en la Ley Básica de la Educación

## II--EDUCACION DE ADULTOS

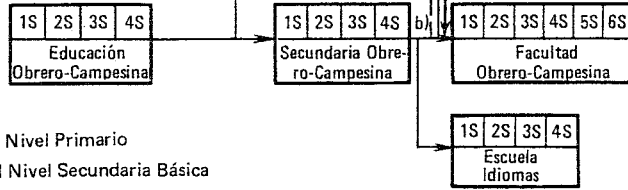

Educación Obrero-Campesina – corresponde al Nivel Primario  
 Secundaria Obrero-Campesina – corresponde al Nivel Secundaria Básica  
 Facultad Obrero-Campesina – corresponde al Nivel Medio Superior

(2 semestres – 1 año escolar)

**MINISTERIO DE EDUCACION**  
 Estructura del Organismo Central  
 (Curso Escolar 1971/72) \*)

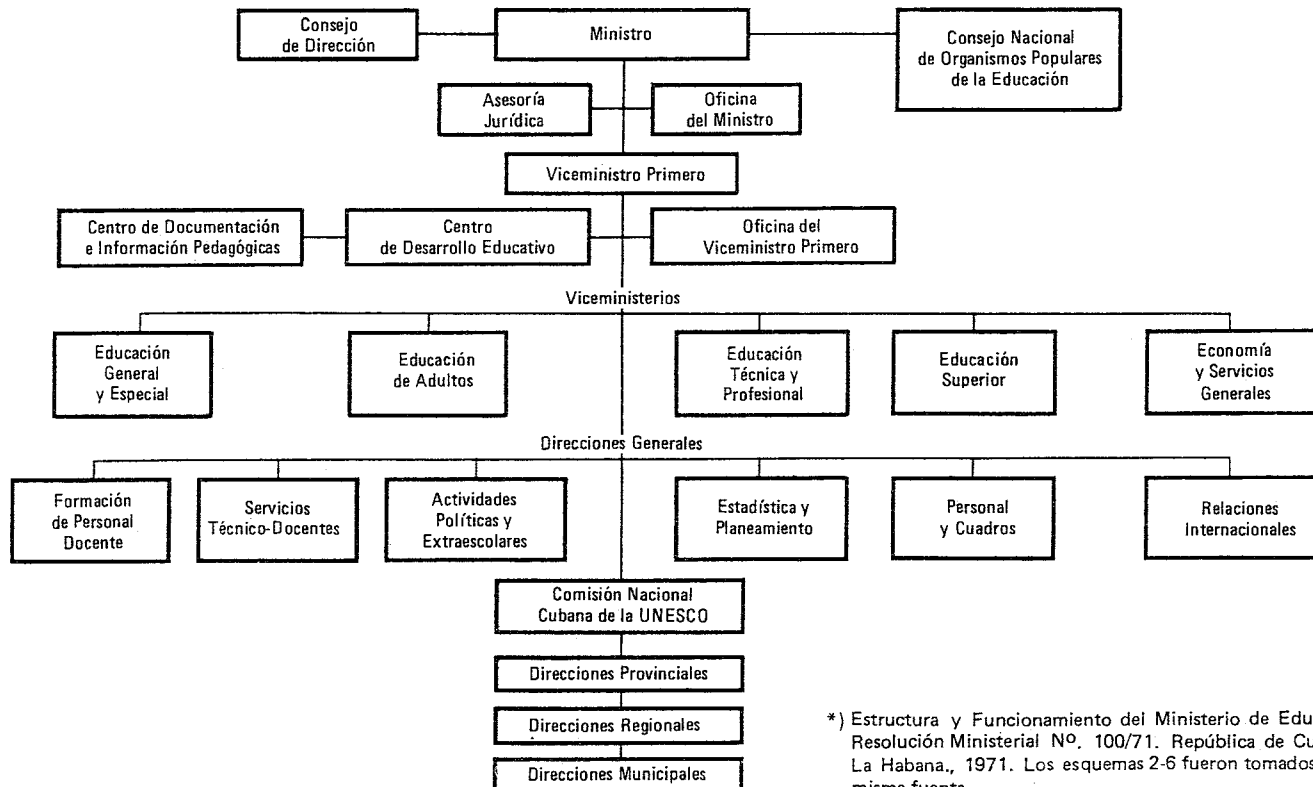

\*) Estructura y Funcionamiento del Ministerio de Educación Resolución Ministerial Nº. 100/71. República de Cuba, La Habana., 1971. Los esquemas 2-6 fueron tomados de esta misma fuente.

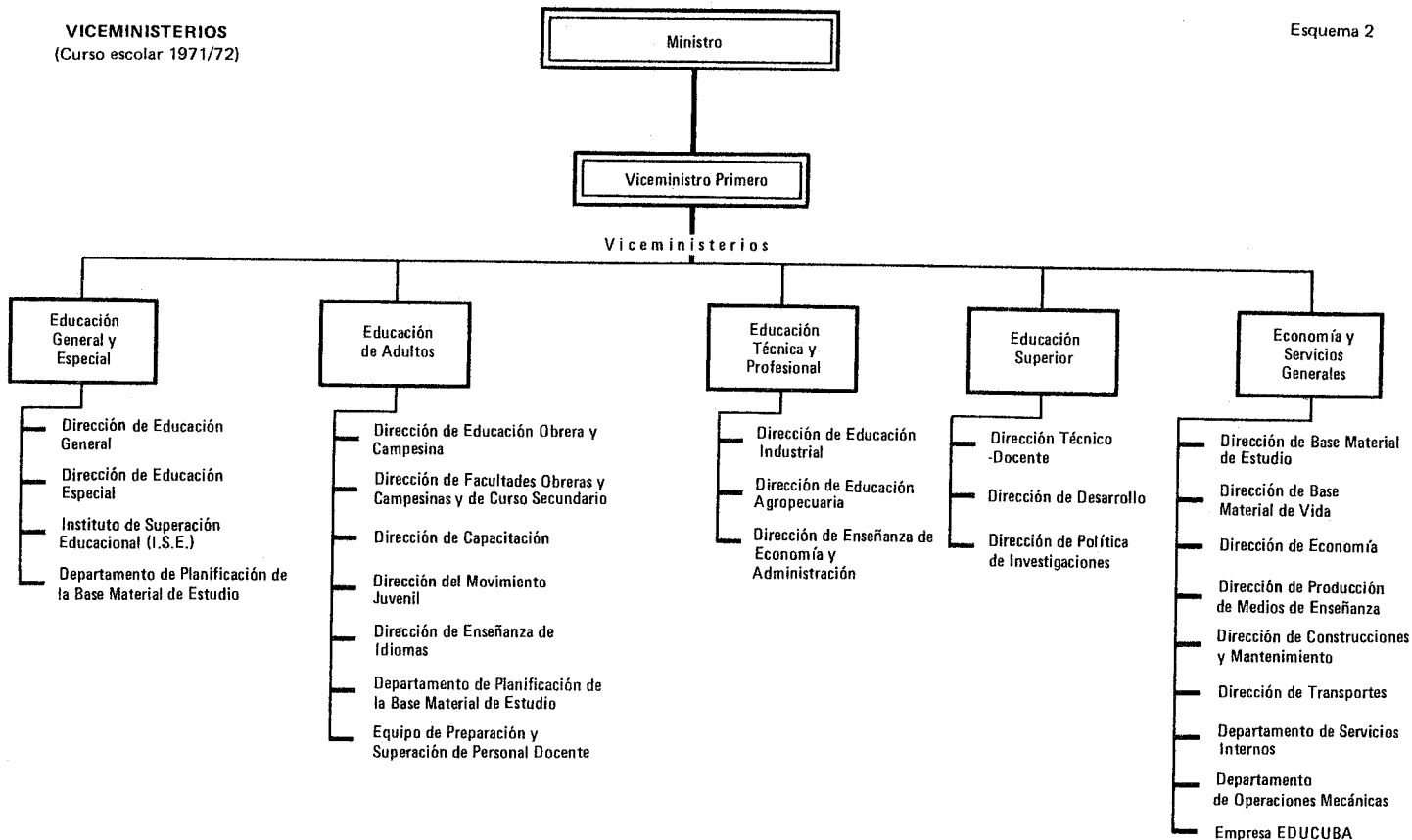

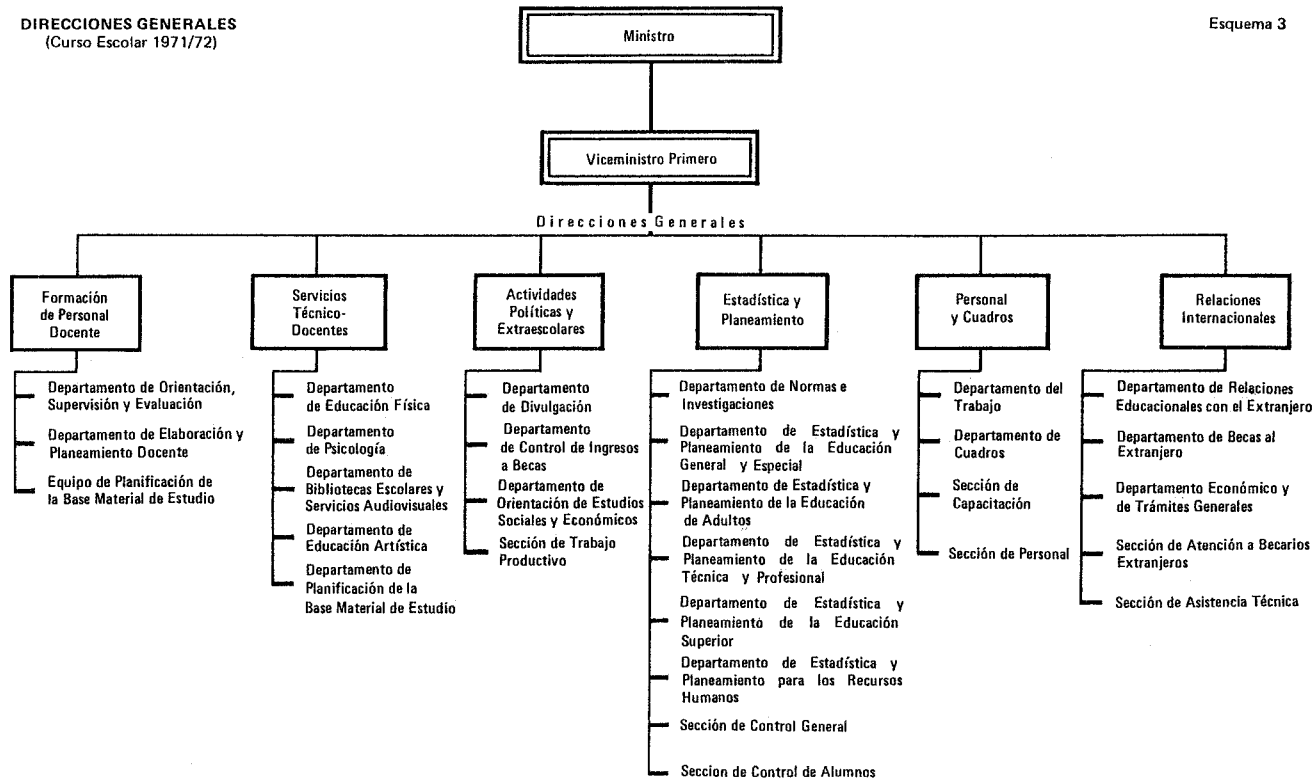

**DIRECCIONES PROVINCIALES**  
(Curso Escolar 1971/72)

Esquema 4

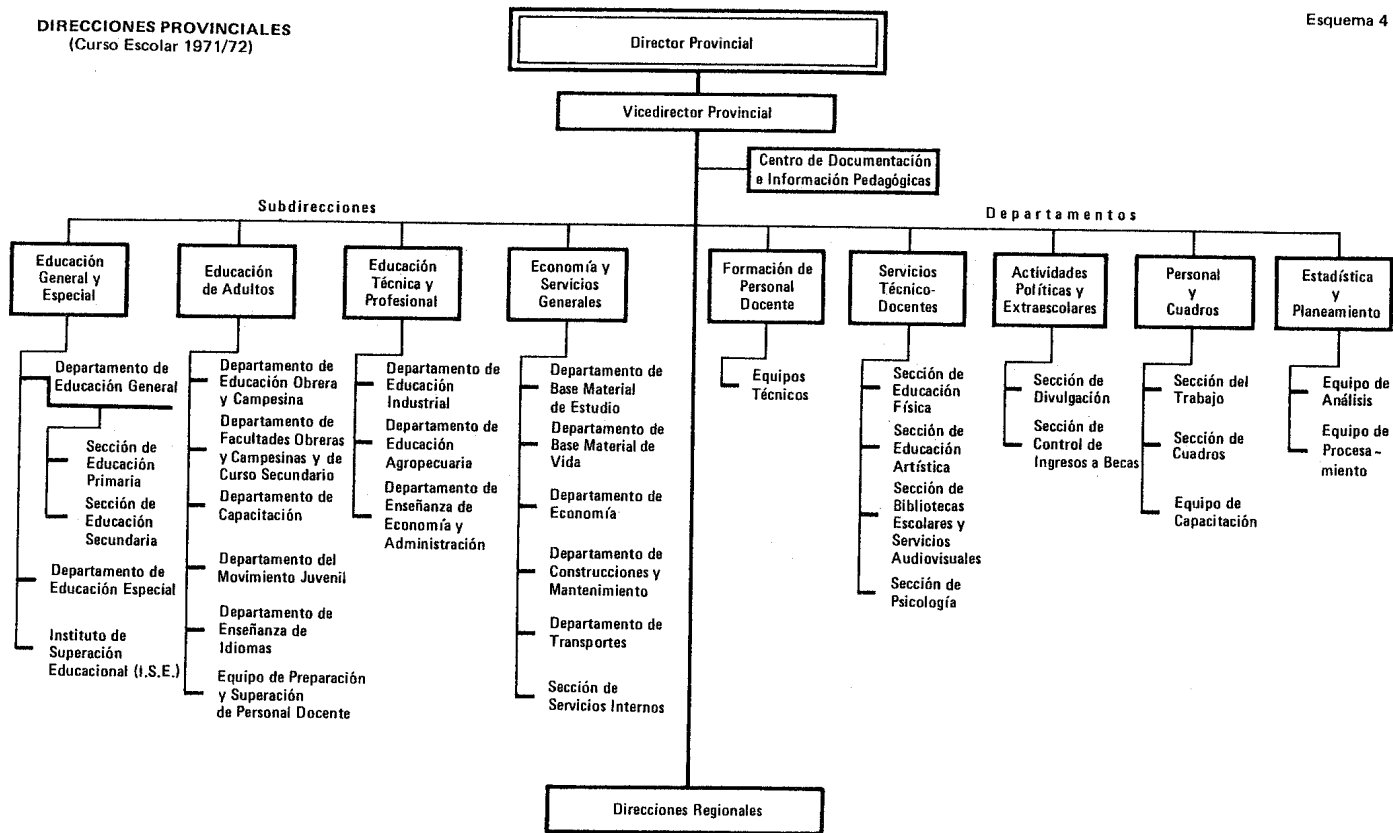

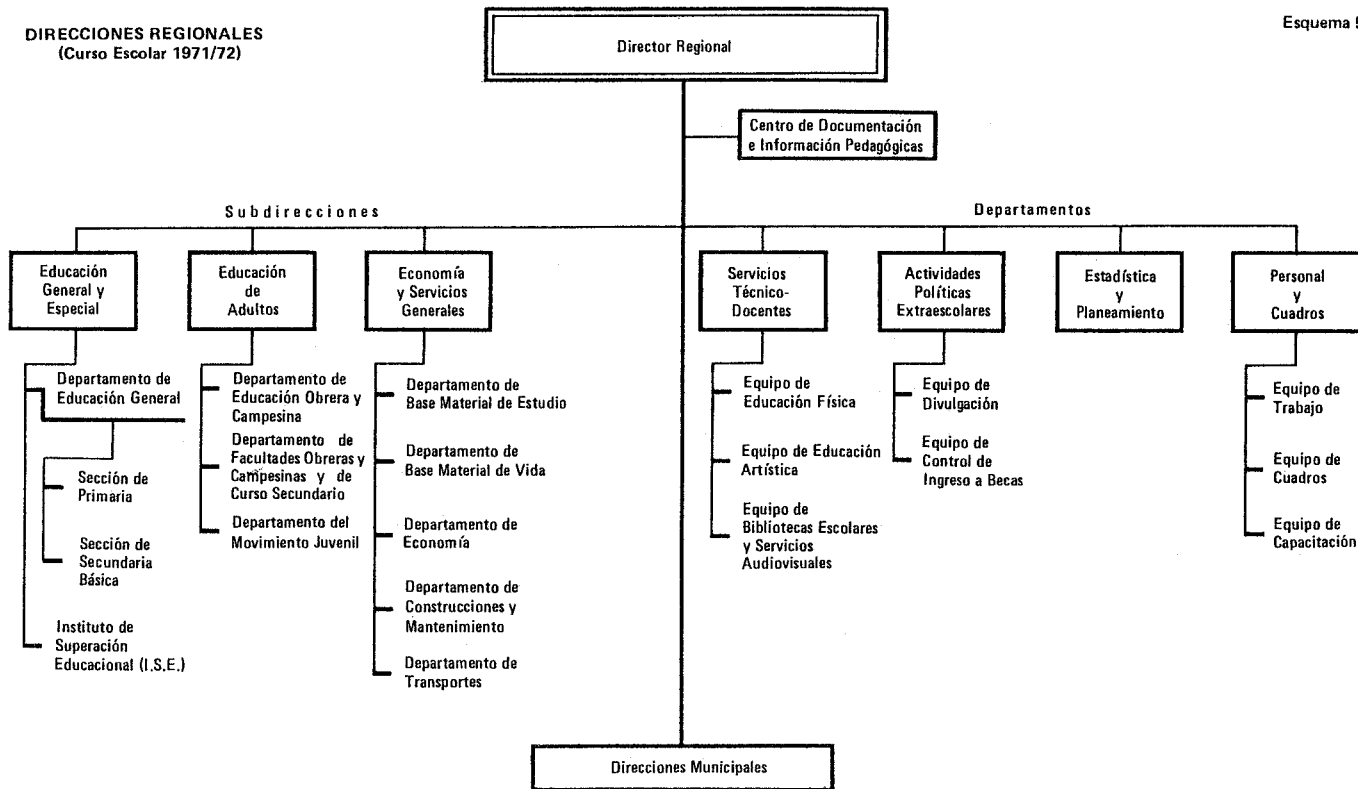



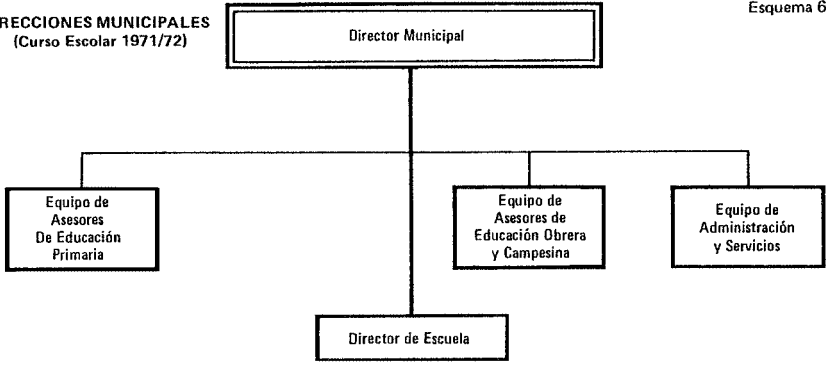

ESTRUCTURA DEL SISTEMA NACIONAL DE ENSEÑANZA \*)  
(Curso Escolar 1971/72)

Esquema 7

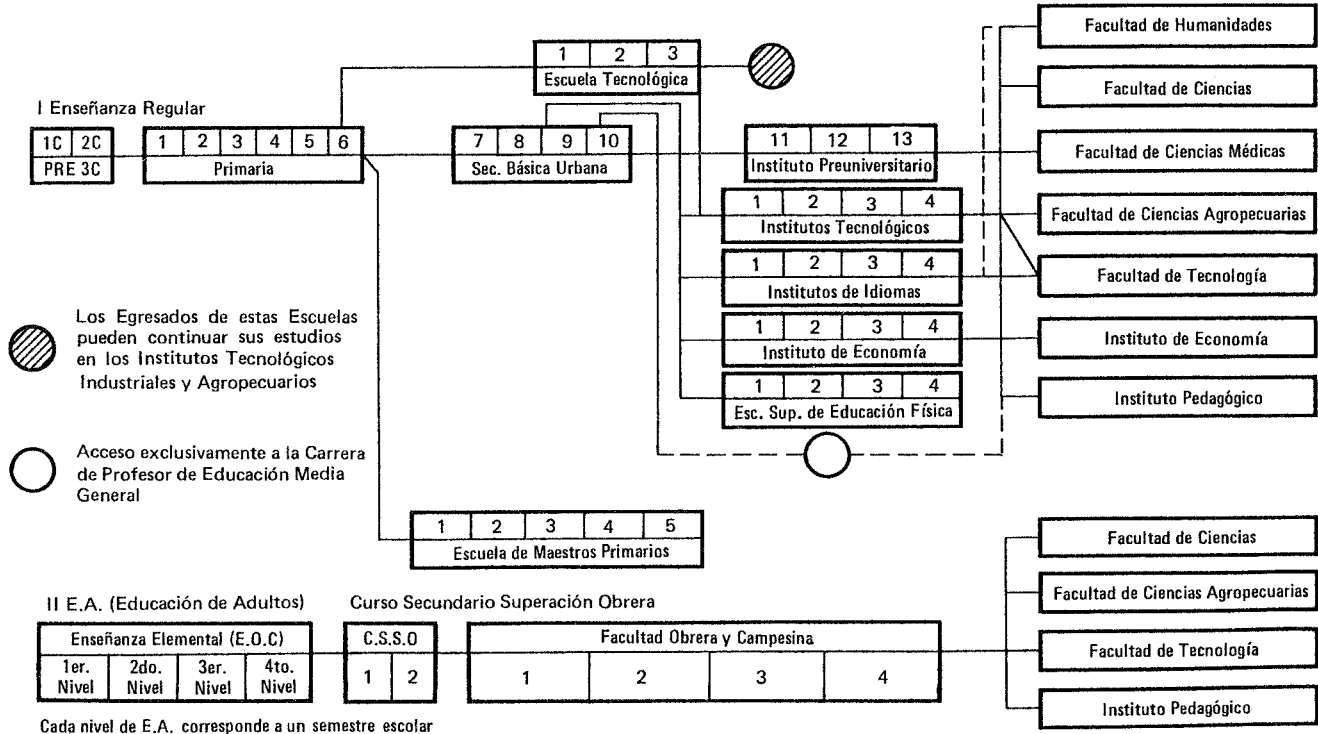

\*) Cuba. XXXIII Conferencia Internacional de Educación OIE-UNESCO. Septiembre, 1971. Ministerio de Educación de Cuba. Págs. 6-7.

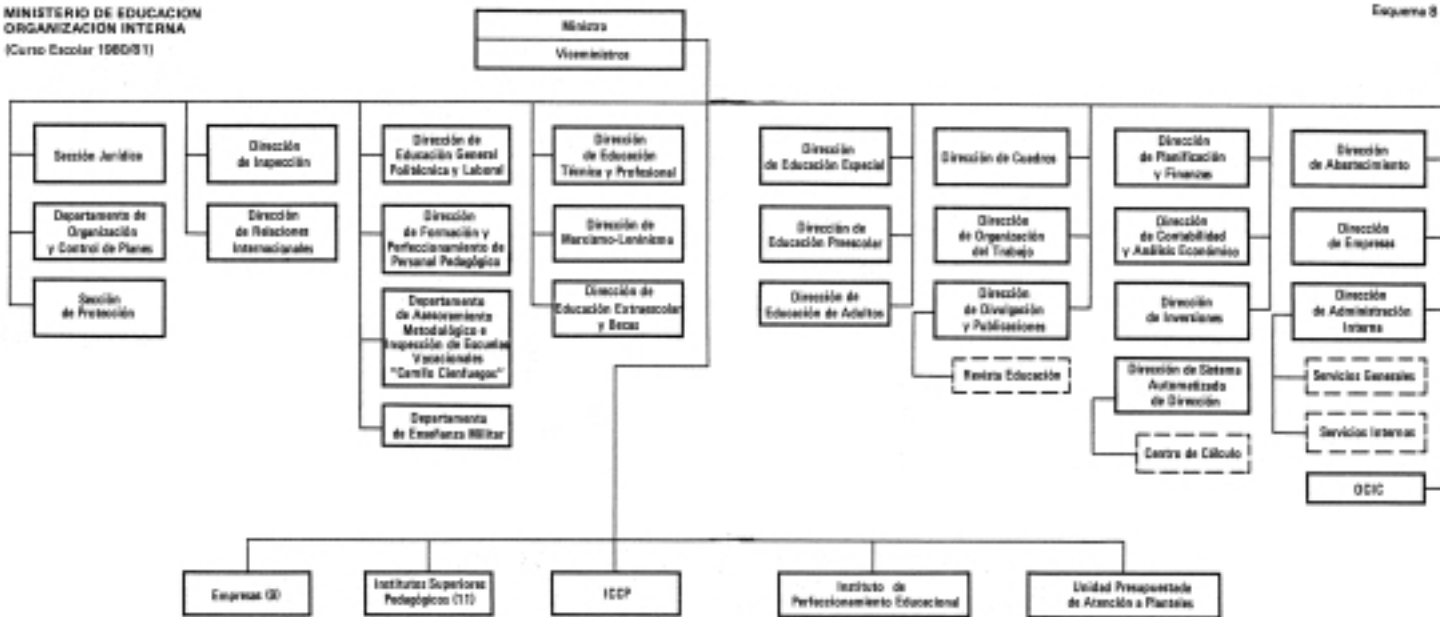

**ESTRUCTURA  
DIRECCION PROVINCIAL DE EDUCACION  
(Curso Escolar 1980/81)**

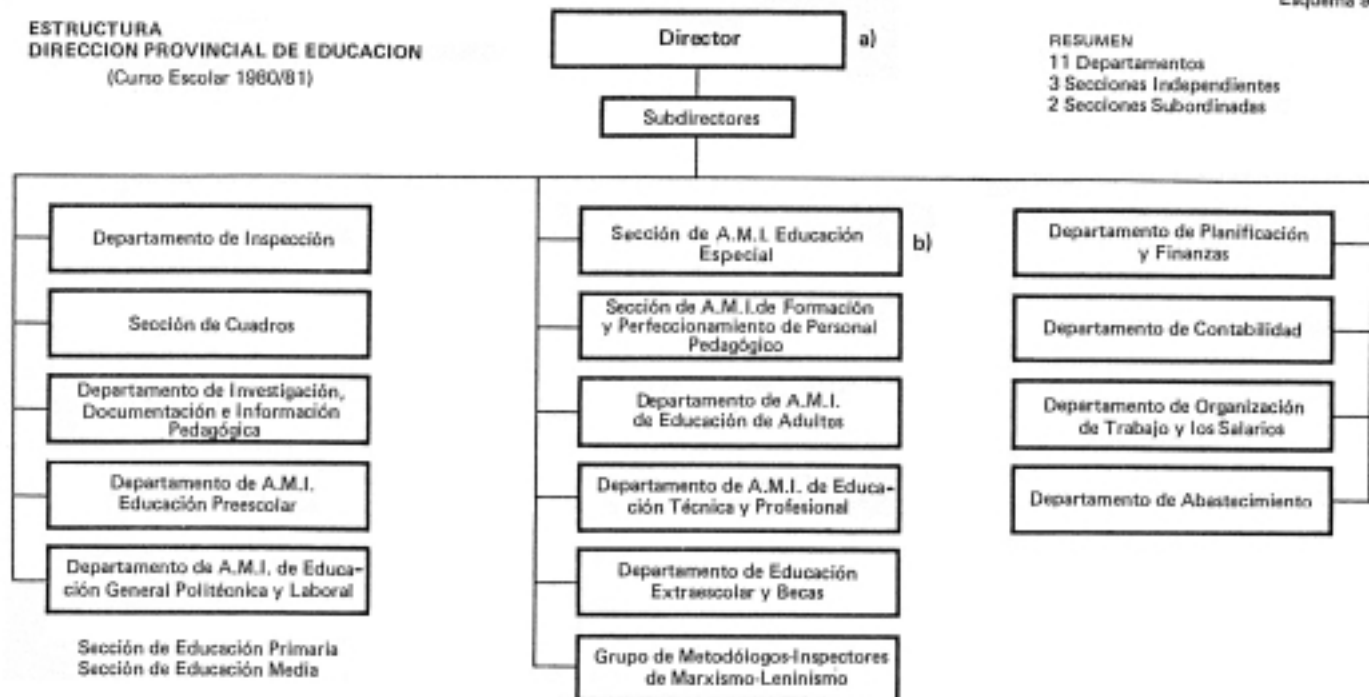

## ORGANOS ADSCRIPTOS

- a) Instituto Provincial de Perfeccionamiento Educacional  
b) Centro de Diagnóstico y Orientación

## LEYENDA

AMI - Asesoramiento Metodológico e Inspección

Además existen Grupos de Trabajo que no constituyen Unidades Organizativas:

- Grupo de A.M.I. de Marxismo-Leninismo
- Grupo de Mantenimiento Constructivo
- Grupo de Diseño de Sistema

**ESTRUCTURA  
DIRECCION MUNICIPAL  
DE EDUCACION**  
(Curso Escolar 1980/81)

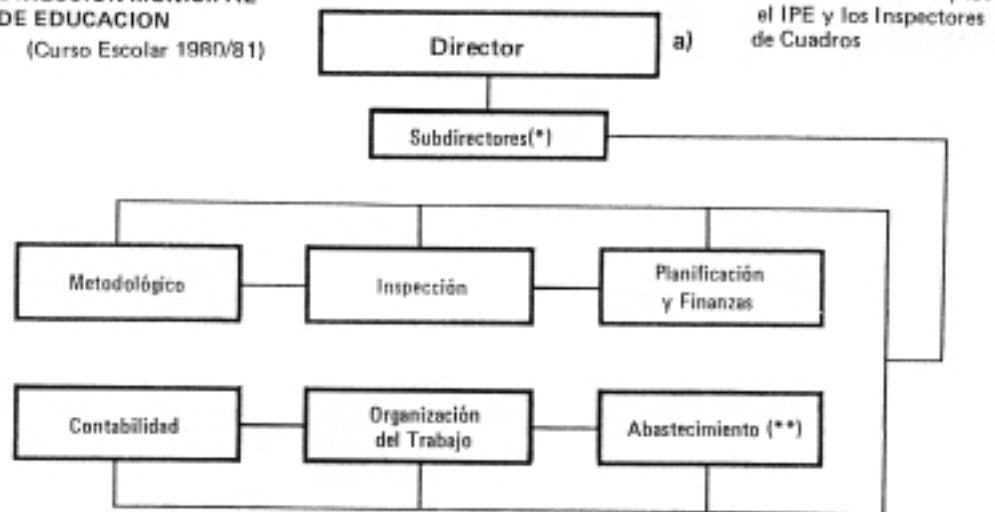

\* Los Municipios Categoría I y II tendrán 3 Subdirectores y los Municipios Categoría III y IV tendrán 2

(\*\*) En los Municipios III y IV no existirá Abastecimiento como Departamento sino como Grupo de Trabajo

a) Instituto Municipal de Perfeccionamiento Educacional

## **Annex B: AEC 2000, Capítulo XV, Educación**

*Source:* República de Cuba. 2001. *Anuario Estadístico de Cuba 2000*.  
Havana: Oficina Nacional de Estadísticas.

*Este capítulo presenta la información estadística de la educación en Cuba desde el círculo infantil hasta el nivel superior. Los datos que se muestran abarcan los indicadores fundamentales de la educación, incluyendo el número de círculos infantiles, escuelas y centros de educación superior, matrícula, graduados y personal docente frente al aula. Se destacan en el capítulo la participación de la mujer en la educación, así como las madres beneficiadas por los círculos infantiles.*

*La principal fuente de información la constituyen los modelos del Sistema de Información Estadística Nacional (SIE-N) y del Sistema de Información Estadística Complementaria (SIE-C) del Ministerio de Educación.*

*La tabla de tasas de escolarización se conforma a partir de los datos de población que brinda la Oficina Nacional de Estadísticas.*

*El universo de la información de este capítulo abarca el total nacional de los círculos infantiles, las escuelas de primaria, secundaria básica, preuniversitaria, técnica y profesional, formación de personal pedagógico, las escuelas especiales, juveniles y de adultos, las cuales son dirigidas administrativamente por las unidades presupuestadas de educación, adscriptas al Poder Popular y dirigidas metodológicamente por el Ministerio de Educación. Se incluyen las escuelas que imparten cursos de nivel medio adscriptas, a otros organismos no especializados en educación. En la educación superior se consideran los centros de enseñanza dirigidos directamente por el Ministerio de Educación, el Ministerio de Educación Superior, el Ministerio de Salud Pública y otros organismos. Esta información no incluye la enseñanza militar ni los cursos dirigidos (libres)*

*La educación desarrolla su trabajo en tres ramas: educación preescolar, primaria y media; educación superior y otras actividades educacionales.*

**Educación preescolar, primaria y media:** *Comprende las unidades presupuestadas dedicadas a las tareas siguientes:*

- *Educación y desarrollo de los niños en círculos infantiles.*
- *Educación preescolar que tiene como objetivo preparar al niño para su incorporación a la educación primaria.*
- *Educación primaria, de primero a sexto grado.*
- *Educación media, que comprende las educaciones secundaria básica, preuniversitaria, técnica y profesional y formación de personal pedagógico.*
- *La educación preuniversitaria comprende del 10mo. al 12mo. grados.*
- *La educación técnica y profesional, forma técnicos medios y obreros calificados en cursos de formación completa y complementación.*
- *La formación de personal pedagógico comprende la formación de educadoras de círculos infantiles, maestros de preescolar, primaria y media, así como profesores de educación física.*

**Educación de adultos:** *Comprende los cursos de la educación obrero campesina (EOC) 6<sup>o</sup> grado, secundaria obrero campesina (SOC) 9<sup>o</sup> grado y la facultad obrero campesina (FOC) 12<sup>mo</sup> grado, así como los centros para la enseñanza de idiomas.*

**Educación técnica y profesional:** *Prepara la fuerza de trabajo calificada de nivel medio que requiere el país en cursos que se imparten en centros politécnicos. De estos centros egresan técnicos medios y obreros calificados en una amplia gama de especialidades en cursos de 2 a 4 años de duración en dependencia de que el ingreso se efectúe con 9<sup>o</sup> o 12<sup>mo</sup> grado. Los técnicos medios además de acceder al mercado de trabajo puede ingresar en la enseñanza superior en carreras afines a la especialidad.*

*Asimismo se incluye en esta educación las escuelas de oficios que en sus inicios se concibieron solamente para jóvenes con retraso escolar y hoy forman obreros calificados con escolaridad desde 9<sup>o</sup> hasta 12<sup>mo</sup> grado.*

**Educación especial:** *Comprende los centros dedicados a la formación de niños, adolescentes y jóvenes con deficiencias mentales, sensoriales o inadaptación escolar y social.*

**Educación superior:** *Forma especialistas de nivel superior en universidades e institutos superiores politécnicos o especializados (medicina, pedagogía, arte, entre otras). La formación general es de 5*



años con excepción de medicina que consta de 6 años.

A continuación se ofrecen la **definición metodológica de los principales indicadores** que aparecen en el capítulo.

**Matrícula inicial:** En las educaciones preescolar, primaria y media es la matrícula registrada el tercer viernes del mes de septiembre, con excepción de la educación técnica y profesional, que es la registrada el segundo viernes del mes de octubre. En la educación superior es la matrícula al 30 de septiembre.

**Graduados:** Son los alumnos que han finalizado satisfactoriamente los estudios correspondientes a un nivel o tipo de educación dado. Son los aprobados del grado o año de estudio terminal de un nivel o tipo de educación.

**Matrícula final en círculos infantiles.** En la cantidad de alumnos matriculados el último día del período que se informa.

**Asistencia promedio a círculos infantiles.** Es la cantidad media de asistencia de los niños matriculados. La asistencia promedio se calcula sumando día a día la asistencia de los niños matriculados y dividiendo el resultado obtenido entre los días del mes (excepto los domingos, días feriados y días cerrados). A partir del promedio mensual se calculan los promedios trimestrales, semestrales y anuales.

**Escuelas por educaciones:** Conjunto de alumnos en uno o varios Grados o Años de estudio organizados para recibir determinado nivel o tipo de educación, dado por uno o varios maestros o profesores bajo la autoridad de un director. En el caso de la educación superior es la institución dedicada a la formación de especialistas de ese nivel desglosándose en Universidades, Institutos Superiores Politécnicos e Institutos Superiores.

**Personal docente por educaciones:** El personal docente comprende los maestros y profesores, directores, sub-directores, auxiliares pedagógicos y bibliotecarios. En la educación superior comprende, el personal de nivel superior con categoría docente; no incluye los alumnos ayudantes ni a los instructores no graduados.

**Personal docente frente al aula por educaciones:** Personal docente que cumple funciones de maestro o profesor; incluye a los directores y subdirectores independientemente que impartan clases o no y al personal contratado.

**Becarios por educaciones:** Alumnos que reciben durante el tiempo

que permanecen matriculados, educación, alimento, vestuario y albergue.

**Seminternos por educaciones:** Alumnos que reciben durante el tiempo que permanecen matriculados, además de educación, alimento y en ocasiones vestuario. En la educación superior se calcula por la capacidad de comensales.

**Tasa de escolarización:** Relación entre la matrícula de una edad o grupo de edades y la población existente en esa edad o grupo de edades.

**Niños de 0 - 5 años por 10.000 niños en esas edades:** Cantidad de niños matriculados en círculos infantiles por 10.000 niños en esas edades.

**XV.1 - INDICADORES GENERALES DE LOS CIRCULOS INFANTILES**

<i>Concepto</i>	<i>Unidad</i>						
	<i>1994</i>	<i>1995</i>	<i>1996</i>	<i>1997</i>	<i>1998</i>	<i>1999</i>	<i>2000</i>
<b>Circuitos infantiles</b>	1 102	1 107	1 114	1 115	1 113	1 118	1 119
<b>Capacidad a final del año</b>	148 656	148 752	148 517	148 403	149 162	149 080	149 040
<b>Matrícula final</b>	144 311	145 569	144 533	145 088	145 364	146 920	146 669
<b>Asistencia promedio anual</b>	105 402	108 365	110 026	111 280	115 404	120 217	122 182
<b>Personal técnico educacional</b>	22 528	21 928	21 960	20 644	19 786	19 270	19 358
<b>Madres beneficiadas</b>	137 616	136 435	135 014	135 012	135 183	137 625	136 956

**XV.2 - MATRICULA FINAL DE LOS CIRCULOS INFANTILES**

<i>Concepto</i>	<i>Unidad</i>						
	<i>1994</i>	<i>1995</i>	<i>1996</i>	<i>1997</i>	<i>1998</i>	<i>1999</i>	<i>2000</i>
<b>Total</b>	144 311	145 569	144 533	145 088	145 364	146 920	146 669
<b>1er. año</b>	6 002	5 882	5 633	5 682	5 471	5 357	5 183
<b>2do. año</b>	19 883	20 955	20 766	20 707	21 301	21 762	20 521
<b>3er. año</b>	28 334	28 880	29 017	29 371	28 980	30 090	30 272
<b>4to. año</b>	33 775	32 420	32 270	32 491	32 848	32 422	33 875
<b>5to. año</b>	35 488	34 908	33 795	33 490	33 576	34 118	33 671
<b>6to. año</b>	20 829	22 524	23 052	23 347	23 188	23 171	23 147
<b>Niños de 0 a 5 años por 10 000 niños en esas edades</b>	1 421	1 518	1 585	1 607	1 640	1 656	1 663

**XV.3 - ASISTENCIA PROMEDIO EN LOS CIRCULOS INFANTILES**

<i>Concepto</i>	<i>Unidad</i>						
	<i>1994</i>	<i>1995</i>	<i>1996</i>	<i>1997</i>	<i>1998</i>	<i>1999</i>	<i>2000</i>
<b>Total</b>	105 402	108 365	110 026	111 280	115 404	120 217	122 182
<b>1er. año</b>	3 335	3 557	3 303	3 515	3 668	3 629	3 885
<b>2do. año</b>	11 338	11 989	12 017	12 200	13 319	14 119	13 628
<b>3er. año</b>	20 499	21 611	21 850	22 434	22 727	24 491	25 026
<b>4to. año</b>	25 696	25 001	25 628	25 909	26 987	27 414	29 059
<b>5to. año</b>	27 298	27 180	27 446	26 976	27 996	29 286	29 277
<b>6to. año</b>	17 236	19 027	19 782	20 246	20 707	21 278	21 307

**XV.4 - INDICADORES GENERALES DE LA EDUCACION**

*Unidad*

<i>Concepto</i>	<i>1994/95</i>	<i>1995/96</i>	<i>1996/97</i>	<i>1997/98</i>	<i>1998/99</i>	<i>1999/00</i>	<i>2000/01</i>
Escuelas	12 254	12 263	12 235	12 284	12 215	12 164	12 207
Personal docente	195 450	202 153	199 747	197 892	195 617	195 917	206 657
Matrícula inicial	2 156 163	2 173 885	2 180 489	2 224 144	2 242 326	2 274 093	2 287 523
Graduados	397 754	383 788	422 055	412 710	433 022	475 590	...
Becarios	301 044	279 845	291 540	316 743	342 416	371 077	404 349
Seminternos	532 087	543 099	524 630	543 608	521 759	529 313	537 181

**XV.5 - ESCUELAS POR EDUCACIONES**

*Unidad*

<i>Concepto</i>	<i>1994/95</i>	<i>1995/96</i>	<i>1996/97</i>	<i>1997/98</i>	<i>1998/99</i>	<i>1999/00</i>	<i>2000/01</i>
Total	12 254	12 363	12 235	12 284	12 215	12 164	12 207
<b>Primaria</b>	9 425	9 420	9 481	9 487	9 401	9 360	9 359
Urbana	2 258	2 260	2 275	2 274	2 269	2 261	2 268
Rural	7 167	7 160	7 206	7 213	7 132	7 099	7 091
<b>Media</b>	1 805	1 978	1 893	1 943	1 966	1 951	1 989
Secundaria básica	971	983	992	1 001	1 014	1 003	1 001
De ello: En el campo	253	253	265	270	275	268	269
Preuniversitario	277	261	252	251	263	274	301
De ello: En el campo	242	212	208	206	216	224	233
Ciencias exactas	15	15	15	15	15	15	15
Ciencias Pedagógicas	-	-	-	-	24	25	28
Vocacional	26	26	26	26	27	27	28
Formación de personal pedagógico	4	2	2	-	-	-	-
MINED	-	-	-	-	-	-	-
Otros organismos	4	2	2	-	-	-	-
Técnica y profesional	527	706	621	665	662	647	659
MINED (a)	365	509	500	498	499	497	497
Otros organismos	162	197	121	167	163	150	162
<b>Adultos</b>	373	389	384	374	365	361	367
EOC	-	-	-	-	-	1	3
SOC	12	15	10	9	5	6	10
FOC	292	306	306	303	303	299	298
Idiomas	69	68	68	62	57	55	56
Escuelas de oficio	162	-	-	-	-	-	-
<b>Especial</b>	456	444	445	443	446	444	443
<b>Superior</b>	33	32	32	37	37	48	49
MES	14	13	13	15	15	15	15
MINED	11	11	11	14	14	15	15
MINSAP	4	4	4	4	4	14	14
Otros organismos	4	4	4	4	4	4	5

(a) A partir del curso 1995/96 incluye las escuelas de oficios en la Educación Técnica y Profesional.

**XV.6 - PERSONAL DOCENTE POR EDUCACIONES**

<i>Concepto</i>	<i>Unidad</i>						
	<i>1994/95</i>	<i>1995/96</i>	<i>1996/97</i>	<i>1997/98</i>	<i>1998/99</i>	<i>1999/00</i>	<i>2000/01</i>
<b>Total</b>	195 450	202 153	199 747	197 892	195 617	195 917	206 657
<b>Prescolar</b>	6 512	7 087	6 605	6 640	6 215	6 116	7 267
<b>Primaria</b>	74 225	78 586	80 223	78 625	77 735	76 897	79 341
<b>Urbana</b>	51 044	53 786	54 549	53 449	53 002	52 203	54 174
<b>Rural</b>	23 181	24 800	25 674	25 176	24 733	24 694	25 167
<b>Media</b>	68 960	73 581	70 104	71 025	70 476	71 613	78 973
<b>Secundaria básica</b>	34 177	36 698	37 241	37 475	36 612	36 532	40 947
<b>De ello: En el campo</b>	6 052	6 360	6 541	6 954	7 164	7 456	9 217
<b>Preuniversitario</b>	9 456	9 516	8 864	9 176	9 605	10 186	12 156
<b>De ello: En el campo</b>	6 323	6 039	5 601	5 719	5 919	6 316	7 391
<b>Formación de personal</b>							
<b>pedagógico</b>	627	301	193	-	-	-	-
<b>MINED</b>	345	188	76	-	-	-	-
<b>Otros organismos</b>	282	113	117	-	-	-	-
<b>Técnica y profesional</b>	24 700	27 066	23 806	24 374	24 259	24 895	25 870
<b>MINED (a)</b>	19 197	21 211	19 728	18 998	18 635	19 404	20 524
<b>Otros organismos</b>	5 503	5 855	4 078	5 376	5 624	5 491	5 346
<b>Adultos</b>	6 765	7 020	6 755	6 454	6 133	5 950	5906
<b>EOC</b>	506	447	387	388	488	445	335
<b>SOC</b>	414	362	402	378	701	717	588
<b>FOC</b>	4 901	5 258	5 037	4 868	4 190	4 069	4 310
<b>Idiomas</b>	944	955	929	820	754	719	673
<b>Escuelas de oficio</b>	3 282	-	-	-	-	-	-
<b>Especial</b>	12 366	12 912	13 486	13 552	13 485	14 023	14 417
<b>Superior</b>	23 340	22 967	22 574	21 596	21 573	21 318	20 753
<b>MES</b>	7 852	7 528	7 562	7 141	6 773	6 470	6 590
<b>MINED</b>	6 263	5 928	5 635	5 518	5 514	5 412	4 993
<b>MINSAP</b>	7 846	8 058	7 974	7 588	8 210	8 322	8 064
<b>Otros organismos</b>	1 379	1 453	1 403	1 349	1 076	1 114	1 106

(a) A partir del curso 1995/96 se incluye el personal de las Escuelas de Oficios.

**XV.7 - PERSONAL DOCENTE FRENTE AL AULA POR EDUCACIONES**
*Unidad*

Concepto	1994/95	1995/96	1996/97	1997/98	1998/99	1999/00	2000/01
<b>Total</b>	172 421	177 251	174 280	171 890	168 968	168 951	178 522
<b>De ellas: Mujeres (a)</b>	105 895	109 999	112 276	108 944	107 521	107 205	123 981
<b>Preescolar</b>	6 312	6 806	6 605	6 640	6 215	6 136	7 267
<b>Primario</b>	57 318	61 102	62 161	60 859	59 468	58 833	60 587
<b>De ellas: Mujeres</b>	43 403	45 658	47 152	55 062	45 920	45 722	47 996
<b>Urbano</b>	35 829	38 024	38 451	37 816	37 179	36 731	38 127
<b>Rural</b>	21 689	23 078	23 730	23 042	22 289	22 102	22 460
<b>Media</b>	66 802	71 457	67 915	68 127	67 615	68 457	75 567
<b>De ellas: Mujeres</b>	33 138	36 587	37 496	36 509	36 725	37 503	41 143
<b>Secundaria básica</b>	32 908	35 482	35 957	35 566	34 668	34 408	38 894
<b>De ellas: En el campo</b>	5 385	6 865	6 380	6 556	6 771	7 028	8 746
<b>Preuniversitario</b>	9 049	9 112	8 461	8 770	9 151	9 648	11 486
<b>De ellas: En el campo</b>	6 612	5 752	5 321	5 427	5 608	5 935	6 941
<b>Formación de personal pedagógico</b>	827	301	193	-	-	-	-
<b>MINED</b>	345	188	76	-	-	-	-
<b>Otros organismos</b>	282	113	117	-	-	-	-
<b>Técnica y profesional</b>	24 218	26 562	23 304	23 831	23 794	24 401	25 087
<b>MINED (b)</b>	18 715	20 707	19 226	18 455	18 170	18 910	19 841
<b>Otros organismos</b>	5 383	5 855	4 078	5 376	5 624	5 491	5 246
<b>Adultos</b>	6 690	6 969	6 688	6 401	6 085	5 892	5 836
<b>EOC</b>	306	445	387	388	488	465	734
<b>SOC</b>	412	361	400	376	700	713	588
<b>FOC</b>	4 843	5 323	4 996	4 831	4 155	4 034	4 258
<b>Idiomas</b>	929	940	915	806	742	700	656
<b>Escuelas de oficio</b>	3 208	-	-	-	-	-	-
<b>Especial</b>	8 351	8 050	8 327	8 267	8 014	8 335	8 312
<b>Superior</b>	23 340	22 967	22 574	21 596	21 573	21 318	20 753
<b>De ellas: Mujeres</b>	10 600	10 382	10 253	10 288	10 288	10 272	10 120
<b>MES</b>	7 852	7 528	7 562	7 141	6 773	6 430	6 380
<b>MINED</b>	6 263	5 928	5 635	5 518	5 514	5 412	4 993
<b>MINSAP</b>	7 846	8 058	7 974	7 588	8 210	8 322	8 064
<b>Otros organismos</b>	1 379	1 453	1 403	1 349	1 076	1 114	1 106

(a) No incluye las habilitas de Técnica y Profesional y la Formación de Personal Pedagógico de Otros Organismos.

(b) A partir del curso 1995/96 incluye las Escuelas de Oficios.

**XV.8 - MATRICULA INICIAL POR EDUCACIONES**

	<i>Unidad</i>						
<i>Concepto</i>	<i>1994/95</i>	<i>1995/96</i>	<i>1996/97</i>	<i>1997/98</i>	<i>1998/99</i>	<i>1999/00</i>	<i>2000/01</i>
<b>Total</b>	2 156 163	2 173 885	2 180 489	2 224 144	2 242 326	2 274 093	2 287 523
<b>Prescolar</b>	160 263	166 256	151 339	141 101	136 397	133 135	134 416
<b>Primaria</b>	1 007 769	1 026 434	1 044 573	1 028 880	1 015 897	987 540	950 357
Urbana	734 539	747 089	760 300	751 512	745 317	724 845	700 651
Rural	273 230	279 345	284 273	277 368	270 580	262 695	249 706
<b>Media</b>	674 152	702 585	710 432	778 028	811 265	865 439	911 033
<b>Secundaria básica</b>	358 491	379 974	410 256	440 820	448 914	467 522	472 705
De ello: En el campo	60 601	60 974	68 999	78 782	84 610	90 271	93 785
<b>Preuniversitario</b>	86 687	78 358	88 021	94 526	107 551	120 119	137 176
De ello: En el campo	60 542	51 288	54 762	63 521	72 474	81 934	90 726
<b>Formación de personal pedagógico</b>	3 779	1 192	394	-	-	-	-
MINED	2 901	955	394	-	-	-	-
Otros organismos	878	237	-	-	-	-	-
<b>Técnica y profesional</b>	225 195	243 061	211 761	242 682	254 800	277 798	301 152
<b>Técnico medio</b>	197 787	182 096	169 448	179 104	190 798	212 898	238 257
MINED	178 638	160 294	150 282	159 332	172 460	195 985	221 812
Otros organismos	19 149	21 802	19 166	19 772	18 338	16 913	16 445
<b>Obrero calificado</b>	27 408	60 965	42 313	63 578	64 002	64 900	62 895
MINED (a)	13 487	37 315	41 666	45 558	47 626	47 414	46 048
Otros organismos	13 921	23 650	647	18 020	16 376	17 486	16 847
<b>Adultos</b>	96 482	103 416	107 020	114 152	117 969	122 057	117 554
EOC	6 184	7 491	10 330	15 386	17 655	16 727	12 886
SOC	6 457	8 957	11 165	13 015	17 110	20 678	19 694
FOC	49 741	57 403	57 825	61 644	60 852	63 588	65 962
Idiomas	24 100	29 565	27 700	24 147	22 352	21 064	18 812
<b>Escuelas de oficio</b>	23 086	-	-	-	-	-	-
Especial	53 596	52 848	55 538	57 348	58 200	59 135	57 629
Superior	140 815	122 346	111 587	104 595	102 598	106 787	116 734
<b>MES</b>	50 385	43 112	39 158	36 590	36 081	39 159	42 064
<b>MINED</b>	47 752	41 102	37 727	35 918	35 720	37 125	39 724
<b>MINSAP</b>	33 437	29 999	27 536	25 311	24 341	23 457	24 606
Otros organismos	9 241	8 133	7 166	6 776	6 456	7 046	10 340

(a) A partir del curso 1995/1996 incluye las Escuelas de Oficios.

**XV.9 - MATRICULA INICIAL (HEMRAS) POR EDUCACIONES**

	<i>Unidad</i>						
<i>Concepto</i>	<i>1994/95</i>	<i>1995/96</i>	<i>1996/97</i>	<i>1997/98</i>	<i>1998/99</i>	<i>1999/00</i>	<i>2000/01</i>
<b>Total</b>	1 078 430	1 082 328	1 094 364	1 108 911	1 119 780	1 132 452	1 141 556
<b>Prescolar</b>	78 363	81 046	73 819	68 818	66 320	64 948	65 167
<b>Primaria</b>	490 621	499 760	508 238	499 422	494 060	480 099	461 931
<b>Media</b>	349 664	352 565	367 276	393 091	408 554	434 973	456 287
<b>Secundaria básica</b>	180 597	192 233	207 683	223 103	225 299	233 731	234 178
<b>Preuniversitario</b>	58 440	52 725	58 524	64 215	72 101	79 687	89 353
<b>Formación de personal pedagógico</b>	2 994	907	391	-	-	-	-
<b>Técnica y profesional (a)</b>	107 633	106 700	100 678	105 773	111 154	121 555	132 756
<b>Técnico medio</b>	104 852	96 587	89 054	93 153	98 438	109 153	121 454
<b>Obrero calificado</b>	2 781	10 113	11 624	12 620	12 716	12 402	11 301
<b>Adultos</b>	53 294	58 607	59 863	65 436	68 159	69 328	67 541
EOC	1 926	2 351	3 020	5 848	7 568	6 073	5 101
SOC	2 476	3 305	4 073	5 347	8 214	9 873	9 254
FOC	30 905	36 293	36 945	40 076	39 325	41 374	42 441
Idiomas	17 987	16 658	15 825	14 165	13 052	12 008	10 731
<b>Escuelas de oficio</b>	7 149	-	-	-	-	-	-
Especial	17 575	17 383	18 034	18 710	18 917	16 314	19 110
Superior	81 764	72 967	67 134	63 434	63 770	66 790	71 521

(a) A partir del curso 1995/96 incluye las Escuelas de Oficios.

**XV.10 - GRADUADOS POR EDUCACIONES**

*Unidad*

<i>Concepto</i>	<i>1994/95</i>	<i>1995/96</i>	<i>1996/97</i>	<i>1997/98</i>	<i>1998/99</i>	<i>1999/00</i>
<b>Total</b>	397 754	383 788	422 055	412 710	433 022	475 590
<b>Primaria</b>	144 872	146 940	167 729	154 140	165 469	172 510
<b>Urbana</b>	110 127	111 336	126 975	116 840	126 334	130 971
<b>Rural</b>	34 745	35 604	40 754	37 300	39 135	41 539
<b>Media</b>	179 055	167 584	187 825	204 211	211 911	242 363
<b>Secundaria básica</b>	93 834	94 537	114 466	123 829	128 878	150 679
<b>De ello: En el campo</b>	14 414	13 470	16 776	18 811	21 703	27 043
<b>Preuniversitario</b>	26 149	20 156	22 319	20 308	23 406	29 574
<b>De ello: En el campo</b>	16 771	13 211	13 682	13 168	15 302	19 504
<b>Formación de personal pedagógico</b>	2 014	582	384	-	-	-
<b>MINED</b>	1 395	464	384	-	-	-
<b>Otros organismos</b>	619	118	-	-	-	-
<b>Técnica y profesional</b>	57 058	52 309	50 656	60 074	59 627	62 110
<b>Técnico medio</b>	50 273	46 846	41 274	38 143	36 834	37 116
<b>MINED</b>	45 266	41 348	34 849	32 717	31 586	32 094
<b>Otros organismos</b>	5 007	5 498	6 425	5 426	5 248	5 022
<b>Obrero calificado</b>	6 785	5 463	9 382	21 931	22 793	24 994
<b>MINED</b>	5 196	4 971	7 523	20 112	21 015	23 479
<b>Otros organismos</b>	1 589	492	1 859	1 819	1 778	1 515
<b>Adultos</b>	28 648	28 912	30 070	31 183	34 777	39 948
<b>EOC</b>	1 736	2 484	3 171	4 673	5 367	7 301
<b>SOC</b>	2 534	3 828	4 267	6 153	7 920	11 285
<b>FOC</b>	13 495	13 995	14 226	13 197	14 723	14 785
<b>Idiomas</b>	10 883	8 605	8 406	7 160	6 767	6 577
<b>Escuelas de oficio (a)</b>	9 949	8 906	8 871	-	-	-
<b>Especial</b>	3 524	3 944	4 080	4 012	4 158	4 273
<b>Superior</b>	31 706	27 502	23 480	19 164	16 707	16 496
<b>MES</b>	11 631	10 501	8 253	6 882	5 360	5 027
<b>MINED</b>	10 938	8 833	7 587	6 106	6 090	5 817
<b>MINSAP</b>	7 029	6 213	6 313	4 952	4 597	4 846
<b>Otros organismos</b>	2 108	1 955	1 327	1 224	660	806

a) A partir del curso 1997/1998 se incluye en educación técnica y profesional.

**XV.11 - GRADUADOS (HEMBRAS) POR EDUCACIONES**

*Unidad*

<i>Concepto</i>	<i>1994/95</i>	<i>1995/96</i>	<i>1996/97</i>	<i>1997/98</i>	<i>1998/99</i>	<i>1999/00</i>
<b>Total</b>	207 652	201 995	220 120	213 683	223 572	244 084
<b>Primaria</b>	72 518	75 034	84 966	76 218	81 079	84 431
<b>Media</b>	95 494	90 017	100 620	106 669	109 477	124 085
<b>Secundaria básica</b>	48 905	49 416	60 433	64 610	66 709	77 174
<b>Preuniversitario</b>	17 402	13 653	14 461	14 143	15 951	19 716
<b>Formación de personal pedagógico</b>	1 268	426	340	-	-	-
<b>Técnica y profesional</b>	27 919	26 522	25 386	27 916	26 817	27 195
<b>Técnico medio</b>	26 964	25 487	23 376	21 217	20 254	20 118
<b>Obrero Calificado</b>	955	1 035	2 010	6 699	6 563	7 077
<b>Adultos</b>	16 124	16 861	16 707	18 197	20 943	23 169
<b>Escuelas de oficio (a)</b>	3 612	3 174	3 309	-	-	-
<b>Especial</b>	1 172	1 343	1 282	1 442	1 367	1 463
<b>Superior</b>	18 732	15 566	13 236	11 157	10 706	10 936

a) A partir del curso 1997/1998 se incluye en educación técnica y profesional.



**XV.12 - BECARIOS POR EDUCACIONES**

*Unidad*

<i>Concepto</i>	<i>1994/95</i>	<i>1995/96</i>	<i>1996/97</i>	<i>1997/98</i>	<i>1998/99</i>	<i>1999/00</i>	<i>2000/01</i>
<b>Total</b>	301 044	279 845	291 540	316 743	342 416	371 077	404 349
<b>Prescolar</b>	31	10	11	32	46	23	44
<b>Primaria</b>	9 704	9 593	8 987	9 741	10 080	9 981	10 309
<b>Urbana</b>	7 357	7 276	6 281	6 426	6 666	6 268	6 519
<b>Rural</b>	2 347	2 317	2 706	3 315	3 414	3 713	3 790
<b>Media</b>	221 496	209 223	224 830	250 664	276 755	303 506	333 303
<b>Secundaria básica</b>	67 214	66 903	76 969	87 687	93 492	99 442	103 112
<b>Preuniversitario</b>	77 140	70 806	78 698	88 212	99 764	110 557	127 024
<b>Formación de personal pedagógico</b>	1 569	494	121	-	-	-	-
<b>MINED</b>	1 225	494	121	-	-	-	-
<b>Otros organismos</b>	344	-	-	-	-	-	-
<b>Técnica y profesional</b>	75 573	71 020	69 042	74 765	83 499	93 507	103 167
<b>Técnico medio</b>	72 196	64 540	63 914	68 984	76 908	87 158	96 732
<b>MINED</b>	68 020	59 267	59 531	63 960	71 920	81 452	90 851
<b>Otros organismos</b>	4 176	5 273	4 383	5 024	4 988	5 706	5 881
<b>Obrero calificado</b>	3 377	6 480	5 128	5 781	6 591	6 349	6 435
<b>MINED (a)</b>	2 371	3 773	4 769	5 160	5 560	4 966	5 372
<b>Otros organismos</b>	1 006	2 707	359	621	1 031	1 383	1 063
<b>Adultos</b>	-	-	-	-	-	-	-
<b>Escuelas de oficio</b>	1 584	-	-	-	-	-	-
<b>Especial</b>	16 355	16 044	16 956	17 293	17 548	17 570	17 458
<b>Superior</b>	51 874	44 975	40 756	39 013	37 987	39 997	43 235
<b>MES</b>	24 634	20 997	19 219	17 864	16 923	18 095	19 299
<b>MINED</b>	13 769	12 976	11 204	11 317	11 282	11 687	12 876
<b>MINSAP</b>	11 846	9 880	9 392	8 947	8 925	9 122	9 810
<b>Otros organismos</b>	1 625	1 122	941	885	857	1 093	1 250

(a) A partir del curso 1995/96 incluye las Escuelas de Oficios.

**XV.13 - SEMINTERNOS POR EDUCACIONES**

*Unidad*

<i>Concepto</i>	<i>1994/95</i>	<i>1995/96</i>	<i>1996/97</i>	<i>1997/98</i>	<i>1998/99</i>	<i>1999/00</i>	<i>2000/01</i>
<b>Total</b>	532 087	543 099	524 630	543 608	521 759	529 313	537 181
<b>Prescolar (a)</b>	50 966	52 831	51 335	49 530	48 385	49 179	51 115
<b>Primaria</b>	360 571	361 539	367 407	369 147	372 511	372 013	369 574
<b>Urbana</b>	348 273	348 553	354 448	356 037	359 091	357 669	354 485
<b>Rural</b>	12 298	12 786	12 959	13 110	13 420	14 344	15 089
<b>Media</b>	71 683	93 402	69 426	85 611	59 192	65 895	71 564
<b>Secundaria básica</b>	8 417	10 246	8 139	8 321	7 781	7 232	8 170
<b>Preuniversitario</b>	1 924	1 734	3 672	552	550	403	534
<b>Formación de personal pedagógico</b>	792	438	112	-	-	-	-
<b>MINED</b>	792	201	112	-	-	-	-
<b>Otros organismos</b>	-	237	-	-	-	-	-
<b>Técnica y profesional</b>	60 550	80 984	57 503	76 758	50 861	58 260	62 860
<b>Técnico medio</b>	45 614	42 856	37 434	38 282	29 169	35 998	40 988
<b>MINED</b>	35 365	32 311	29 113	28 564	27 274	28 872	32 184
<b>Otros organismos</b>	10 249	10 545	8 321	9 718	1 895	7 126	8 804
<b>Obrero calificado</b>	14 936	38 128	20 069	38 456	21 692	22 262	21 872
<b>MINED (b)</b>	3 575	18 386	20 069	22 378	21 692	22 262	21 628
<b>Otros organismos</b>	11 361	19 742	-	16 078	-	-	244
<b>Escuelas de oficio</b>	14 934	-	-	-	-	-	-
<b>Especial</b>	30 908	30 349	31 464	31 833	32 161	32 247	31 524
<b>Superior</b>	3 025	5 178	4 998	7 487	9 510	9 979	13 404
<b>MES</b>	...	2 648	2 436	2 918	2 835	4 095	4 505
<b>MINED</b>	...	1 181	1 455	3 646	5 467	4 702	7 245
<b>MINSAP</b>	...	104	33	44	643	652	661
<b>Otros organismos</b>	...	1 245	1 074	879	565	530	993

(a) Incluye prescolar de círculos infantiles.

(b) A partir del curso 1995/96 incluye las Escuelas de Oficios.

**XV.14 - MATRICULA INICIAL DE LA EDUCACION TECNICA Y PROFESIONAL**  
*(Según el Clasificador Uniforme de Actividades Educativas CUAE)*

Unidad

Grupos de Especialidades	1994/95	1995/96	1996/97	1997/98	1998/99	1999/00	2000/01
<b>Total</b>	225 195	243 061	211 761	242 682	254 800	277 798	301 152
<b>Técnico medio</b>	197 787	182 096	169 448	179 104	190 798	212 898	238 257
Geología, minería y metalurgia	2 722	2 456	2 293	2 352	2 418	2 518	2 767
Energética	12 678	11 161	9 956	10 817	11 448	12 439	12 904
Construcción de maquinarias	17 810	15 531	14 719	16 229	17 842	19 594	21 264
Industrias azucarera, química y alimenticia	8 500	8 304	7 519	6 994	6 816	7 379	7 724
Electrónica, automatización y comunicaciones	8 488	7 986	7 384	8 160	8 970	9 056	9 965
Transporte	9 320	7 993	6 713	6 995	7 371	8 819	10 201
Construcción	18 033	15 271	11 248	12 374	14 180	15 487	17 367
Producción agropecuaria	48 732	43 684	42 383	44 807	46 458	50 960	53 184
Economía	38 054	23 593	24 647	28 974	35 168	44 045	53 096
Salud pública	10 863	11 871	11 826	12 118	11 747	11 349	11 554
Arte	2 144	2 219	2 548	2 879	2 793	2 739	2 761
Otras	20 443	32 027	28 212	26 405	25 587	28 513	35 470
<b>Obrero calificado</b>	27 408	60 965	42 313	63 578	64 002	64 900	62 895
Geología, minería y metalurgia	96	93	121	125	118	129	99
Energética	594	399	246	302	340	364	400
Construcción de maquinarias	3 650	5 015	3 359	4 131	3 669	4 031	3 732
Transporte	1 611	1 845	1 603	1 644	1 698	1 745	1 797
Construcción	16 420	22 721	2 219	18 219	17 942	19 649	19 740
Producción agropecuaria	308	885	491	1 218	501	55	117
Salud	-	-	-	-	-	164	290
Otras (a)	4 729	30 007	34 274	37 939	39 734	38 763	36 720

(a) A partir del curso 1995/96 se incluyen las especialidades que se imparten en las Escuelas de Oficios.

**XV.15 - GRADUADOS DE LA EDUCACION TECNICA Y PROFESIONAL**  
*(Según el Clasificador Uniforme de Actividades Educativas CUAE)*

*Unidad*

<i>Grupos de Especialidades</i>	<i>1993/94</i>	<i>1994/95</i>	<i>1995/96</i>	<i>1996/97</i>	<i>1997/98</i>	<i>1998/99</i>	<i>1999/00</i>
<b>Total</b>	58 570	57 058	52 309	50 656	60 074	59 627	62 110
<b>Técnico medio</b>	52 352	50 273	46 846	41 274	38 143	36 834	37 116
<b>Geología, minería y metalurgia</b>	750	607	573	491	455	431	373
<b>Energética</b>	3 430	3 482	3 033	1 873	2 018	1 820	1 943
<b>Construcción de maquinarias</b>	4 873	4 611	3 845	3 015	2 884	3 008	3 137
<b>Industrias azucarera, química y alimenticia</b>	1 881	2 217	2 125	2 075	1 768	1 460	1 477
<b>Electrónica, automatización y comunicaciones</b>	2 254	2 036	1 958	1 871	1 742	1 791	1 432
<b>Transporte</b>	2 154	2 324	2 048	1 600	1 461	1 208	1 147
<b>Construcción</b>	6 440	5 454	4 138	2 734	1 876	1 949	2 140
<b>Producción agropecuaria</b>	8 950	10 482	10 101	7 861	7 253	7 375	8 014
<b>Economía</b>	13 585	7 597	6 250	6 039	6 825	6 995	8 014
<b>Salud pública</b>	4 104	2 880	4 034	4 073	3 989	3 729	3 586
<b>Arte</b>	520	477	383	564	595	549	475
<b>Otras</b>	3 431	8 106	8 358	9 078	7 277	6 519	5 378
<b>Obrero calificado</b>	6 218	6 785	5 463	9 382	21 931	22 793	24 994
<b>Geología, minería y metalurgia</b>	59	57	20	50	41	36	51
<b>Energética</b>	275	249	196	83	94	129	138
<b>Construcción de maquinarias</b>	1 753	1 640	1 387	1 838	1 948	1 944	1 219
<b>Transporte</b>	761	602	838	642	593	711	635
<b>Construcción</b>	2 400	2 244	791	1 958	1 851	2 097	2 195
<b>Producción agropecuaria</b>	70	181	2 231	-	54	4	-
<b>Salud pública</b>	-	-	-	-	150	107	87
<b>Otras (a)</b>	900	1 812	-	4 811	17 200	17 765	20 669

a) A partir del curso 1997/1998 se incluyen los Obreros Calificados de las Escuelas de Oficios.

**XV.16 - MATRICULA INICIAL DE LA EDUCACION SUPERIOR POR RAMAS DE LA CIENCIA**

*Unidad*

<i>Ramas de la Ciencia</i>	<i>1994/95</i>	<i>1995/96</i>	<i>1996/97</i>	<i>1997/98</i>	<i>1998/99</i>	<i>1999/00</i>	<i>2000/01</i>
<b>Total</b>	140 815	122 346	111 587	104 595	102 598	106 787	116 734
<b>Ciencias Técnicas</b>	21 708	17 985	15 753	13 888	13 020	13 474	14 514
<b>Ciencias Naturales y Matemáticas</b>	5 510	5 174	4 931	4 579	4 087	4 019	3 828
<b>Ciencias Agropecuarias</b>	8 131	6 567	5 194	4 946	4 680	4 984	5 125
<b>Ciencias Económicas</b>	5 426	4 893	5 095	6 000	7 399	9 505	11 061
<b>Ciencias Sociales y Humanísticas</b>	5 736	5 366	5 569	5 762	5 781	6 084	6 385
<b>Ciencias Médicas</b>	33 437	29 999	27 536	25 311	24 541	23 457	24 606
<b>Pedagogía</b>	48 169	41 487	38 152	35 352	35 068	36 359	38 892
<b>Cultura Física</b>	11 859	10 135	8 650	7 946	7 464	8 000	11 269
<b>Arte</b>	839	740	707	811	758	905	1 054

**XV.17 - GRADUADOS DE LA EDUCACION SUPERIOR POR RAMAS DE LA CIENCIA**

*Unidad*

<i>Ramas de la ciencia</i>	<i>1993/94</i>	<i>1994/95</i>	<i>1995/96</i>	<i>1996/97</i>	<i>1997/98</i>	<i>1998/99</i>	<i>1999/00</i>
<b>Total</b>	31 015	31 706	27 502	23 480	19 164	16 707	16 496
<b>Ciencias Técnicas</b>	5 532	5 189	5 204	3 703	2 671	1 954	1 843
<b>Ciencias Naturales y Matemáticas</b>	856	799	951	958	1 022	769	756
<b>Ciencias Agropecuarias</b>	2 039	2 029	1 395	1 436	1 097	967	685
<b>Ciencias Económicas</b>	1 646	1 456	1 127	758	716	623	712
<b>Ciencias Sociales y Humanísticas</b>	1 198	1 250	841	957	1 003	844	965
<b>Ciencias Médicas</b>	6 604	7 029	6 213	6 313	4 952	4 597	4 846
<b>Pedagogía</b>	10 636	10 975	8 891	7 456	6 020	6 057	5 742
<b>Cultura Física</b>	2 411	2 840	2 782	1 803	1 603	786	847
<b>Arte</b>	93	139	98	96	80	110	100

**XV.18 - MATRICULA INICIAL POR 10 000 HABITANTES**

*Unidad*

<i>Concepto</i>	<i>1994/95</i>	<i>1995/96</i>	<i>1996/97</i>	<i>1997/98</i>	<i>1998/99</i>	<i>1999/00</i>	<i>2000/01</i>
Primaria	920	935	951	930	913	885	849
Secundaria básica	327	346	374	398	403	419	422
Preuniversitario	79	72	80	85	96	81	122
Técnica y profesional	206	222	194	218	228	249	269
Técnico medio	181	166	155	161	171	191	213
Obrero calificado	25	56	39	57	57	58	56
Formación de personal pedagógico	3	1	1	-	-	-	-
Superior	129	111	102	95	92	95	104

**XV.19 - TASA DE ESCOLARIZACION POR PROVINCIAS Y GRUPOS DE EDADES**

*Por ciento*

<i>Provincias</i>	<i>1992/93</i>			<i>1994/95</i>		
	<i>6-11</i>	<i>12-14</i>	<i>6-14</i>	<i>6-11</i>	<i>12-14</i>	<i>6-14</i>
Total	99,3	92,3	97,4	99,2	90,7	96,7
Pinar del Río	100,0	88,3	96,3	100,0	82,7	94,9
La Habana	100,0	96,3	98,9	100,0	96,6	99,0
Ciudad de La Habana	98,2	91,6	96,2	98,7	94,4	97,5
Matanzas	100,0	92,3	97,6	100,0	89,1	96,9
Villa Clara	99,0	95,3	97,8	98,9	91,0	96,6
Cienfuegos	99,9	91,7	97,5	98,8	89,2	96,0
Sancti Spiritus	100,0	94,2	98,2	100,0	94,0	98,2
Ciego de Avila	99,3	95,8	98,2	100,0	92,0	97,6
Camagüey	99,8	95,4	98,5	99,3	92,5	97,3
Las Tunas	99,8	89,6	96,8	99,6	85,1	95,3
Holguín	99,6	89,4	96,6	98,0	85,6	94,6
Granma	97,7	93,7	96,5	99,2	90,6	96,6
Santiago de Cuba	100,0	94,4	98,4	98,5	92,3	96,7
Guantánamo	100,0	87,0	96,0	100,0	89,3	96,9
Isla de la Juventud	100,0	90,1	97,1	100,0	94,1	98,2

**XV.19 - TASA DE ESCOLARIZACION POR PROVINCIAS Y GRUPOS DE EDADES (Conclusión)**

Por ciento

Provincias	1994/95			1995/96			1996/97		
	6-11	12-14	6-14	6-11	12-14	6-14	6-11	12-14	6-14
Cuba	99,2	90,7	96,7	99,7	92,3	97,5	99,4	92,9	97,4
Pinar del Río	100,0	82,7	94,9	100,0	85,7	96,1	100,0	90,9	97,5
La Habana	100,0	96,6	99,0	100,0	98,2	100,0	99,6	97,8	99,1
Ciudad de l.a Habana	98,7	94,4	97,5	100,0	100,0	100,0	97,5	94,4	96,5
Matanzas	100,0	89,1	96,9	100,0	88,5	97,6	99,0	91,7	96,8
Villa Clara	98,9	91,0	96,6	98,0	93,5	96,7	98,4	93,1	96,8
Cienfuegos	98,8	89,2	96,0	99,7	87,6	96,1	98,3	90,9	96,0
Sancti Spiritus	100,0	94,0	98,2	98,1	96,6	97,6	99,7	93,2	97,7
Ciego de Avila	100,0	92,0	97,6	99,4	94,3	97,9	99,5	94,6	98,0
Camagüey	99,3	92,5	97,3	98,9	89,6	96,1	99,1	91,8	96,8
Las Tunas	99,6	85,1	95,3	98,4	83,4	93,9	98,6	89,4	95,8
Holguín	98,0	85,6	94,6	97,2	87,8	94,5	99,1	89,8	96,3
Granma	99,2	90,6	96,6	98,4	89,3	95,6	100,0	92,5	97,9
Santiago de Cuba	98,5	92,3	96,7	99,7	95,2	98,3	100,0	95,3	99,2
Guantánamo	100,0	89,3	96,9	100,0	86,5	96,7	100,0	91,2	99,4
Isla de la Juventud	100,0	94,1	98,2	100,0	94,1	100,0	100,0	97,5	100,0

Provincias	1997/98			1998/99			1999/00		
	6-11	12-14	6-14	6-11	12-14	6-14	6-11	12-14	6-14
Cuba	99,3	94,6	97,8	99,3	95,8	98,2	99,1	96,3	98,2
Pinar del Río	100,0	90,9	97,6	100,0	93,3	97,9	99,6	95,6	98,3
La Habana	99,6	96,0	98,5	99,1	97,2	98,5	98,9	97,2	98,3
Ciudad de La Habana	97,4	96,1	97,0	98,0	98,7	98,2	97,9	98,3	98,0
Matanzas	98,3	99,7	98,8	99,3	95,7	98,2	99,3	95,3	98,0
Villa Clara	98,3	94,1	97,0	97,9	95,2	97,1	97,7	96,2	97,2
Cienfuegos	99,7	89,6	96,4	98,5	93,6	96,9	98,8	95,1	97,5
Sancti Spiritus	99,6	92,9	97,5	100,0	93,5	98,1	99,6	96,4	98,6
Ciego de Avila	98,7	95,4	97,7	99,0	96,8	98,3	98,8	95,7	97,8
Camagüey	99,1	93,1	97,2	98,9	95,8	97,9	99,3	96,3	98,3
Las Tunas	99,8	93,4	97,8	99,9	94,0	98,0	98,9	93,7	97,2
Holguín	99,0	92,8	97,1	98,8	92,8	96,8	98,7	95,0	97,4
Granma	99,5	93,6	97,6	99,1	94,0	97,5	99,1	95,1	97,8
Santiago de Cuba	100,0	96,2	99,8	100,0	97,5	99,7	100,0	97,1	99,2
Guantánamo	100,0	95,7	99,6	100,0	95,2	99,6	100,0	95,8	99,5
Isla de la Juventud	100,0	100,0	100,0	100,0	100,0	100,0	100,0	100,0	100,0

## **About the Author**

**Graciella Cruz-Taura** (Ph.D. University of Miami, 1978) is Associate Professor of History at the Dorothy F. Schmidt College of Arts and Letters, Florida Atlantic University, Boca Raton, Florida.



## **Institute for Cuban and Cuban-American Studies - ICCAS**

The Institute for Cuban and Cuban-American Studies is unique in that ICCAS is a leading Center for Cuban Studies emphasizing the dissemination of Cuban history and culture. ICCAS sponsors academic and outreach programs and helps coordinate Cuban-related activities at the University of Miami including the Casa Bacardi; the Emilio Bacardi Moreau Chair in Cuban Studies; the Cuba Transition Project; the Cuban Heritage Collection at Otto G. Richter Library; the John J. Koubek Memorial Center, and other University components related to Cuban and Cuban-American Studies.

### **Programs and Activities**

The Institute undertakes a variety of programs and activities, including sponsoring and hosting public lectures and seminars. The Institute's Information Center provides current and historical information on Cuba and responds to requests from the academic, business, media and government communities. ICCAS publishes research studies and occasional papers, sponsors original research, and coordinates interdisciplinary courses at the University of Miami. The Institute also organizes art exhibits, musical programs, and an annual film festival.

## Recently Published by the CTP

- After Castro: Alternative Regimes and U.S. Policy* – **Edward González**
- The Cuban Communist Party and Electoral Politics: Adaptation, Succession, and Transition* – **William M. LeoGrande**
- Growing Economic and Social Disparities in Cuba: Impact and Recommendations for Change* – **Carmelo Mesa Lago**
- A Transparency/Accountability Framework for Combating Corruption in Post-Castro Cuba* – **Sergio Díaz Briquets and Jorge Pérez López**
- Socio-Economic Reconstruction: Suggestions and Recommendations for Post-Castro Cuba* – **Antonio Jorge**
- The Spanish Transition and the Case of Cuba* – **Carlos Alberto Montaner**
- The Role of the Judiciary: Alternative Recommendations for Change* – **Laura Patallo Sánchez**
- International Organizations and Post-Castro Cuba* – **Ernesto Betancourt**
- The Cuban Military and Transition Dynamics* – **Brian Latell**
- The Role of Education in Promoting Cuba's Integration into the International Society: Lessons in Transition from the Post-Communist States of Central and Eastern Europe* – **Andy Gómez**
- The Greatest Challenge: Civic Values in Post-Transition Cuba* – **Damian J. Fernández**
- Privatization Strategies, Market Efficiency, and Economic Development in Post-Castro Cuba* – **Antonio Jorge**
- Establishing The Rule of Law in Cuba* – **Laura Patallo Sánchez**
- A Constitution for Cuba's Political Transition: The Utility of Retaining (and Amending) the 1992 Constitution* – **Jorge I. Domínguez**
- The Role of the Cuban-American Community in the Cuban Transition* – **Sergio Díaz Briquets and Jorge Pérez López**
- The Cuban Transition: Lessons from the Romanian Experience* – **Michael Radu**
- Foreign Direct Investment in Post-Castro Cuba: Problems, Opportunities, and Recommendations* – **Robert David Cruz**

## Forthcoming CTP Publications

- Confiscated Properties in a Post-Castro Cuba: Two Views* – **Matias Travieso**, “Alternative Recommendations for Dealing with Confiscated Properties in Post-Castro Cuba” and **Oscar M. Garibaldi**, “The Treatment of Expropriated Property in a Post-Castro Cuba” with an introduction by **Laura Patallo Sánchez**
- What Has Gone Wrong with Transitions in Post Communist Eastern Europe: Lessons for Cuba* – **Vendulka Kubalkova**
- Nicaragua: Political Processes and Democratic Transition - Possible Lessons for Cuba* – **Alvaro Taboada Terán**
- Republic of Cuba Telecommunications Fundamental Plan* – **Manuel Cereijo**
- Securing the Future: A Blueprint for the Reconstruction of Cuba's Security Services* – **Eugene Rothman**